

Einfust, S.A.

# **CATALOGO - TARIFA DE PRECIOS**

# **2011**

**EINFUST, S.A.**  
**Pi i Sunyer, 5**  
**08192 Sant Quirze del Vallès**  
**Barcelona**

**Telef. 937 123 001**  
**[einfust@einfust.com](mailto:einfust@einfust.com)**

**Fax 937 122 246**

## **CONDICIONES DE VENTA**

### **Precios**

Todos los precios de esta tarifa y de nuestras ofertas, son sin impuestos. El I.V.A. o cualquier otro impuesto se repercutirán en la correspondiente factura.

### **Pedidos**

Los pedidos de herramientas especiales son considerados en firme desde su recepción. En caso de posterior anulación o modificación, el cliente aceptará el cargo que proceda por las operaciones realizadas hasta el momento.

Los planos, croquis, plantillas o nuestras de madera facilitados por nuestros clientes para la fabricación de las herramientas quedan en nuestra propiedad para ser utilizados como justificante en caso necesario, y serán conservados hasta 12 meses después del suministro.

### **Devoluciones**

Cualquier devolución de material requiere nuestra previa aceptación. El importe del abono se compensará con suministros posteriores, previa reducción del 5% como gasto de manipulación.

### **Plazos de entrega**

Los plazos de entrega que facilitamos son a título orientativo. Cualquier demora en el suministro no da lugar a anulación o a indemnización.

### **Expediciones**

Todos nuestros envíos viajan por cuenta y riesgo del comprador. Si se acordara la expedición con pago de porte en origen, este será cargado en la factura.

En caso de observar anomalías en la expedición (falta de peso, embalaje averiado, etc.) debe efectuarse la reclamación o reserva ante el Transportista.

### **Garantía**

Nuestras herramientas están garantizadas contra eventuales defectos de materiales o de fabricación, comprometiéndonos a la reparación o sustitución de las mismas, previa conformidad de nuestros técnicos.

Esta garantía excluye las herramientas que no hayan sido empleadas según normas o condiciones correctas, usadas a velocidades inadecuadas, mal afiladas o trabajando materiales no adecuados a su calidad.

## CONDICIONES DE TRABAJO

### VELOCIDAD DE CORTE

Si se pretende obtener el máximo rendimiento de una herramienta, debe trabajar a la velocidad adecuada.

La velocidad se halla en función de su diámetro exterior, clase del material a trabajar y grado del acabado que se pretende obtener.

Como normas generales, indicamos las velocidades más apropiadas, expresadas en metros por segundo.

### MATERIAL A TRABAJAR

### CALIDAD HERRAMIENTA

	H.S.S.	M.D.
Madera blanda (tipo pino)	55/60	60/90 m/seg.
Madera media (tipo haya)	50/55	60/80 m/seg.
Madera dura y colonial	45/50	50/70 m/seg.
Aglomerado sin chapar		60/80 m/seg.
Contrachapados		40/70 m/seg.
Tableros revestidos		50/70 m/seg.
Estratificado sin encolar		40/60 m/seg.
Madera comprimida		30/50 m/seg.
Materiales plásticos		25/45 m/seg.
Aluminio		25/45 m/seg.

CUADRO PARA DETERMINAR EL NUMERO DE REVOLUCIONES POR MINUTO SEGUN LOS DIFERENTES DIAMETROS Y DIVERSAS VELOCIDADES DE CORTE.

r.p.m.	DIAMETROS																	
	80	100	110	120	130	140	150	160	180	200	220	250	260	280	300	320	350	400
2.000							16	17	19	21	23	26	27	29	31	34	37	42
2.500				16	17	18	20	21	24	26	29	33	34	37	39	42	46	52
3.000		16	17	19	20	22	24	25	28	31	35	39	41	44	47	50	55	63
3.500	15	18	20	22	24	26	27	29	33	37	40	46	48	51	55	59	64	73
4.000	17	21	23	25	27	29	31	34	38	42	46	52	54	59	63	67	73	84
4.500	19	24	26	28	31	33	35	38	42	47	52	59	61	66	71	75	82	94
5.000	21	26	29	31	34	37	39	42	47	52	58	66	68	73	79	84	92	
6.000	25	31	35	38	41	44	47	50	57	63	69	79	82	88	94			
7.000	29	37	40	44	48	51	55	59	66	73	81	92	95					
8.000	34	42	46	50	54	59	63	67	75	84	92							
9.000	38	47	52	57	61	66	71	75	85	94								
10.000	42	52	58	63	68	73	79	84	94									
12.000	50	63	69	75	82	88	94											
14.000	59	73	81	88	95													
16.000	67	84	92															
18.000	75	94																

### SEGURIDAD DE EMPLEO

Nunca deben superarse las r.p.m. indicadas en el Cuadro anterior y en las herramientas.

## AVANCE

La velocidad de avance del material, expresada en metros de trabajo por minuto, es determinante para conseguir la calidad de acabado que se pretenda.

Dicha calidad de acabado se halla en función del espesor de viruta arrancada por cada diente de la herramienta, y por lo tanto se ve afectada por la velocidad de rotación, número de dientes, y velocidad de alimentación.

La tabla siguiente permite determinar la mejor velocidad de avance, en función de la calidad deseada. Para ello, debe tomarse en consideración el grueso medio de viruta, en función del número de cortes por minuto (A=) obtenido de la multiplicación de dientes por r.p.m.

Superficie óptima:	Grueso viruta (B) = 0,2 a 0,4 mm.
Superficie buena:	Grueso viruta (B) = 0,6 a 0,8 mm.
Superficie regular:	Grueso viruta (B) = 1,0 a 1,2 mm.
Superficie basta:	Grueso viruta (B) = 1,4 a 1,6 mm.

A =	B							
	0,2	0,4	0,6	0,8	1	1,2	1,4	1,6
6.000	1,2	2,4	3,6	4,8	6	7,2	8,4	9,6
8.000	1,6	3,2	4,8	6,4	8	9,6	11,2	12,8
10.000	2	4	6	8	10	12	14	16
12.000	2,4	4,8	7,2	9,6	12	14,4	16,8	19,2
14.000	2,8	5,6	8,4	11,2	14	16,8	19,6	22,4
16.000	3,2	6,4	9,6	12,8	16	19,2	22,4	25,6
18.000	3,6	7,2	10,8	14,4	18	21,6	25,2	28,8
20.000	4	8	12	16	20	24	28	32
24.000	4,8	9,6	14,4	19,2	24	28,8	33,6	38,4
28.000	5,6	11,2	16,8	22,4	28	33,6	39,2	44,8
32.000	6,4	12,8	19,2	25,6	32	38,4	44,8	51,2
36.000	7,2	14,4	21,6	28,8	36	43,2	50,4	57,6
40.000	8	16	24	32	40	48	56	64

## ROTACION Y POSICION DE TRABAJO DE LAS FRESAS

---

**A**

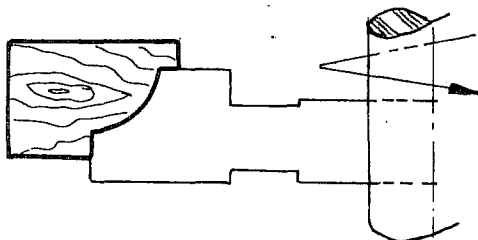

Posición normal para moldurar en tupí vertical.  
Posición normal para contramoldura superior en tupí vertical.

**B**

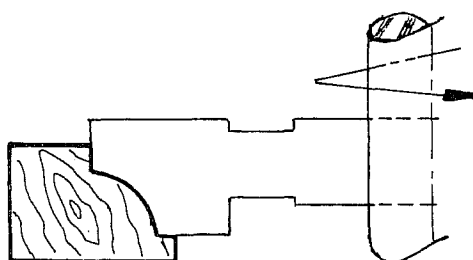

Posición normal superior para rebajar plafones en tupí vertical.  
Posición normal para contramoldura inferior en tupí vertical.

**C**

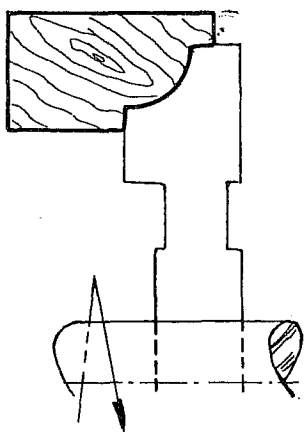

Posición normal para moldurar en eje horizontal.

**D**

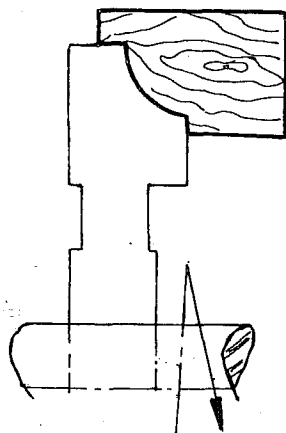

Posición normal para rebajar plafones en eje horizontal.

## COMO DETERMINAR LOS DIAMETROS EXTERIORES DE LAS FRESAS CON PERFIL

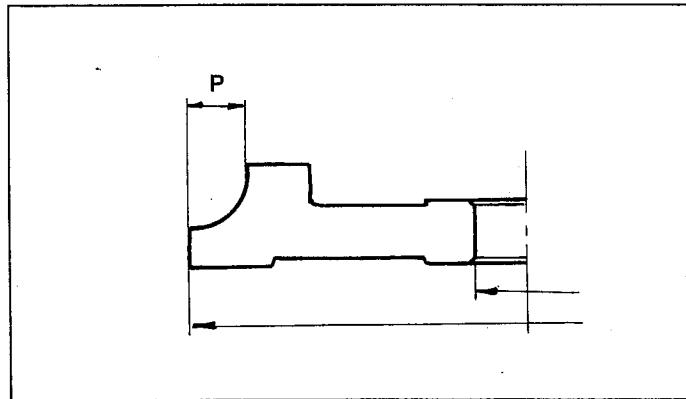

P =	10	15	20	25	30	35	40	45	50 mm.
Agujero hasta 40 mm. $\varnothing$	120	120	140	140	160	170	180	200	210 mm.
Agujero hasta 50 mm. $\varnothing$	130	140	150	160	180	190	200	210	220 mm.

## COMO DETERMINAR LOS ANCHOS DE CORTE DE LAS FRESAS CON PERFIL

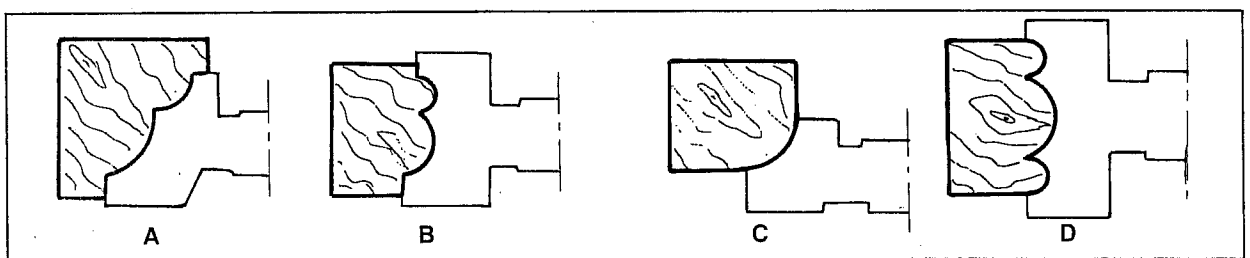

**ANCHO DE CORTE DE LA FRESA «A».**— La fresa tendrá 2 mm. más de ancho que la parte de madera trabajada.

**ANCHO DE CORTE DE LA FRESA «B».**— Se aumentarán 4 mm. al ancho total de la madera, ya que la herramienta debe exceder 2 mm. por cada lado de la madera.

**ANCHO DE CORTE DE LA FRESA «C».**— Aumentar el ancho de la madera a trabajar con los mm. señalados en la siguiente tabla, de acuerdo con la profundidad del perfil:

Profundidad del perfil hasta	10 mm. aumentar	6 mm.
Profundidad del perfil hasta	20 mm. aumentar	8 mm.
Profundidad del perfil hasta	30 mm. aumentar	10 mm.
Profundidad del perfil superior a	30 mm. aumentar	12/15 mm.

**ANCHO DE CORTE DE LA FRESA «D».**— Se aumentará el doble que en las del perfil «C».

## **TARIFA MODIFICACIONES**

### **Agrandar agujero**

#### **Fresas**

Fresas HSS o MD hasta 50 mm. ancho	<b>18,50 €</b>
Fresas HSS o MD de 51 a 100 mm. ancho	<b>26,50 €</b>
Fresas SR macizo hasta 50 mm. ancho	<b>40,50 €</b>

#### **Portacuchillas**

Portacuchillas hasta 50 mm. ancho	<b>18,50 €</b>
Portacuchillas de 51 a 100 mm. ancho	<b>26,50 €</b>

#### **Sierras**

Sierras hasta D.350 y agujero hasta 50 mm.	<b>13,50 €</b>
Sierras hasta D.350 y agujero de 51 a 100 mm.	<b>19,90 €</b>

### **Reducción de agujero**

Se suministrará con la herramienta un juego de anillos reducción ref. 701 o anillo ref. 700, aplicando el precio de tarifa.

### **Chaveteros (Precio de una entalla)**

<b>Fresas</b>	<b>18,50 €</b>
<b>Portacuchillas</b>	
Hasta 50 mm. de ancho	<b>19,50 €</b>
De 51 a 100 mm. de ancho	<b>23,50 €</b>
<b>Sierras</b>	
Únicamente en las sierras de nueva fabricación	<b>19,00 €</b>

### **Rebajar mango**

Siempre que sea técnicamente posible y cumpla las normas de seguridad.	<b>20,60 €</b>
--	----------------

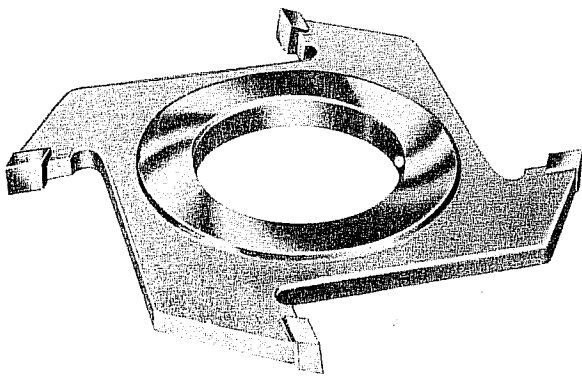
**MEC- ALIMENTACION MECANICA**

<b>Dia.</b>	<b>Ancho</b>	<b>Eje</b>	<b>MD</b>
120	3	30	<b>63,60 €</b>
120	4	30	<b>61,50 €</b>
120	5	30	<b>67,50 €</b>
120	6	30	<b>67,50 €</b>
120	7	30	<b>75,05 €</b>
120	8	30	<b>75,05 €</b>
120	9	30	<b>81,80 €</b>
120	10	30	<b>81,80 €</b>
120	11	30	<b>90,50 €</b>
120	12	30	<b>90,50 €</b>
120	15	30	<b>102,40 €</b>
140	3	50	<b>64,50 €</b>
140	4	50	<b>62,40 €</b>
140	5	50	<b>68,64 €</b>
140	6	50	<b>68,64 €</b>
140	7	50	<b>76,15 €</b>
140	8	50	<b>76,15 €</b>
140	9	50	<b>83,50 €</b>
140	10	50	<b>83,50 €</b>
140	11	50	<b>91,88 €</b>
140	12	50	<b>91,88 €</b>
140	15	50	<b>104,50 €</b>
140	16	50	<b>108,65 €</b>

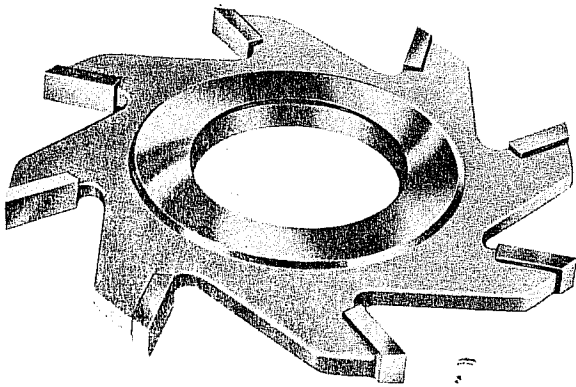
**MEC- ALIMENTACION MECANICA**

<b>Dia.</b>	<b>Ancho</b>	<b>Eje</b>	<b>HSS</b>	<b>MD</b>
120	3	30	<b>75,50</b>	
120	4	30	<b>73,95</b>	
120	5	30	<b>82,26</b>	
120	6	30	<b>82,26</b>	
120	7	30	<b>92,05</b>	
120	8	30	<b>92,05</b>	
120	9	30	<b>99,05</b>	
120	10	30	<b>99,05</b>	
120	11	30	<b>105,99</b>	
120	12	30	<b>105,99</b>	
120	15	30	<b>115,90</b>	
140	3	50	<b>77,04</b>	<b>83,20 €</b>
140	4	50	<b>75,25</b>	<b>81,54 €</b>
140	5	50	<b>83,74</b>	<b>90,92 €</b>
140	6	50	<b>83,74</b>	<b>90,92 €</b>
140	7	50	<b>93,50</b>	<b>97,70 €</b>
140	8	50	<b>93,50</b>	<b>97,70 €</b>
140	9	50	<b>101,90</b>	<b>102,62 €</b>
140	10	50	<b>101,90</b>	<b>102,62 €</b>
140	11	50	<b>108,55</b>	<b>109,30 €</b>
140	12	50	<b>108,55</b>	<b>109,30 €</b>
140	15	50	<b>119,10</b>	<b>119,50 €</b>
140	16	50	<b>131,35</b>	<b>133,10 €</b>
140	21	50	<b>137,11</b>	<b>138,50 €</b>
160	21	50	<b>143,45</b>	<b>145,10 €</b>

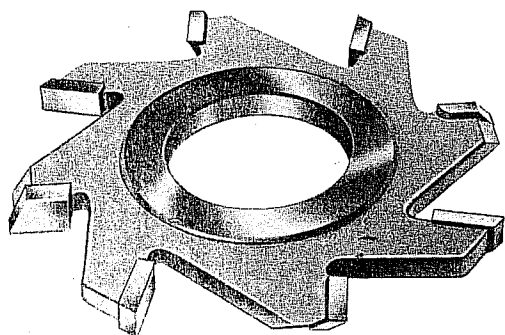
**104 FRESA RANURAR****4 Cortes+4 prec.****MEC- ALIMENTACION MECANICA**

<b>Dia</b>	<b>Ancho</b>	<b>Eje</b>	<b>HSS</b>	<b>MD</b>
120	3	30	101,95	<b>102,97 €</b>
120	4	30	98,98	<b>99,97 €</b>
120	5	30	108,47	<b>109,55 €</b>
120	6	30	108,47	<b>109,55 €</b>
120	7	30	118,27	<b>119,45 €</b>
120	8	30	118,27	<b>119,45 €</b>
120	9	30	128,19	<b>129,47 €</b>
120	10	30	128,19	<b>129,47 €</b>
120	11	30	138,39	<b>139,77 €</b>
120	12	30	138,39	<b>139,77 €</b>
120	15	30	155,81	<b>157,37 €</b>
140	3	50	103,18	<b>104,21 €</b>
140	4	50	100,18	<b>102,18 €</b>
140	5	50	109,90	<b>112,10 €</b>
140	6	50	109,90	<b>112,10 €</b>
140	7	50	119,91	<b>122,30 €</b>
140	8	50	119,91	<b>122,30 €</b>
140	9	50	130,09	<b>131,50 €</b>
140	10	50	130,09	<b>131,50 €</b>
140	11	50	140,63	<b>142,04 €</b>
140	12	50	140,63	<b>142,04 €</b>
140	15	50	155,81	<b>157,37 €</b>
140	16	50	163,60	<b>165,24 €</b>
160	21	50	190,35	<b>192,10 €</b>

**106 FRESA PARA ENCASTAR**

**12 CORTES**

**MAN-ALIMENTACION MANUAL**

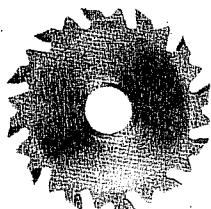

D.100x3,97x22 agujero Z-12 MD

**34,05 €**

**110 JGO. FRESAS RANURAR**

**4 Cortes + 4 prec.**

**MEC- ALIMENTACION MECANICA**

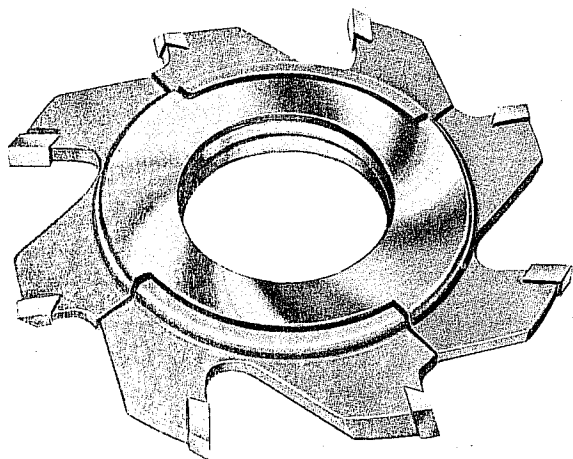

<u>Dia.</u>	<u>Ancho</u>	<u>Eje</u>	<u>HSS</u>	<u>MD</u>
120	4/7,6	30	<b>191,55</b>	<b>202,40 €</b>
120	7/13,6	30	<b>199,07</b>	<b>210,25 €</b>
120	10/19,6	30	<b>213,50</b>	<b>221,41 €</b>
140	4/7,6	50	<b>195,30</b>	<b>205,06 €</b>
140	5/9,6	50	<b>199,40</b>	<b>209,40 €</b>
140	7/13,6	50	<b>204,35</b>	<b>213,75 €</b>
140	10/19,6	50	<b>216,50</b>	<b>225,99 €</b>
180	4/7,6	30	<b>222,08</b>	<b>230,54 €</b>
180	7/13,6	30	<b>233,59</b>	<b>242,57 €</b>
180	10/19,6	30	<b>245,10</b>	<b>257,66 €</b>

Se suministran con 1 juego de anillos decimales

**111 JGO. FRESAS RANURAS PEQUEÑAS**

**4 cortes +4 prec.**

**MAN-ALIMENTACION MANUAL**

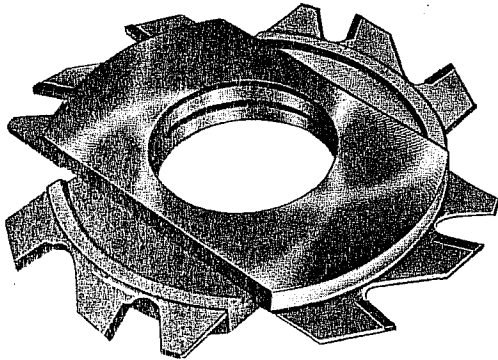

<u>Dia.</u>	<u>Ancho</u>	<u>Eje</u>	<u>MD</u>
140	1,8/3,4	50	177,10 €
140	2,5/4,8	50	189,90 €

Se suministra con 1 juego de anillos decimales

**112 JGO. FRESAS RANURAR**

**4 cortes +4 prec./4Z rect.**

**MEC- ALIMENTACION MECANICA**

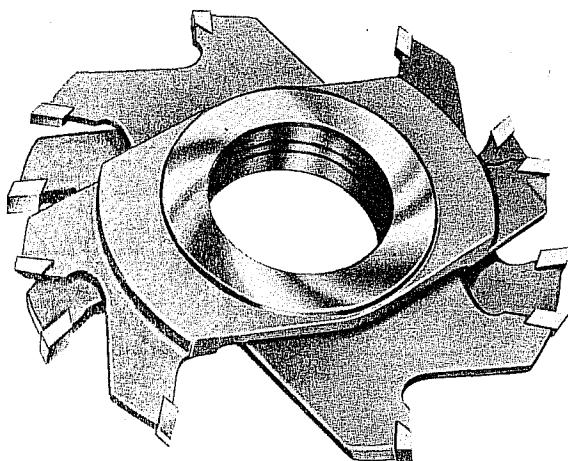

<u>Dia</u>	<u>Ancho</u>	<u>Eje</u>	<u>HSS</u>	<u>MD</u>
160	5/9,8	50	<b>196,90</b>	<b>205,10 €</b>
160	10	50	<b>88,32</b>	<b>92,00 €</b>
160	5/19,8	50	<b>285,22</b>	<b>297,10 €</b>

Se suministran con 1 juego de anillos decimales

**114 JGO. FRESAS RANURAR**

**4 cortes+8 prec.**

**MEC- ALIMENTACION MECANICA**

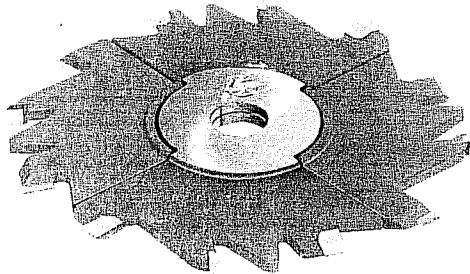

<u>Dia.</u>	<u>Ancho</u>	<u>Eje</u>	<u>HSS</u>	<u>MD</u>
200	5/9,6	30	<b>365,80</b>	<b>388,33 €</b>
200	10/19,6	30	<b>380,18</b>	<b>407,89 €</b>
200	15/29,6	30	<b>484,95</b>	<b>520,29 €</b>
250	5/9,6	30	<b>392,62</b>	<b>416,80 €</b>
250	10/19,6	30	<b>433,18</b>	<b>459,90 €</b>
250	15/29,6	30	<b>569,72</b>	<b>604,85 €</b>
300	5/9,6	30	<b>419,77</b>	<b>445,63 €</b>
300	10/19,6	30	<b>489,43</b>	<b>519,52 €</b>
300	15/29,6	30	<b>650,00</b>	<b>690,10 €</b>

Se suministran con 1 juego anillos decimales

**120 FRESA GALCES**

**4 cortes alternos**

**MEC- ALIMENTACION MECANICA**

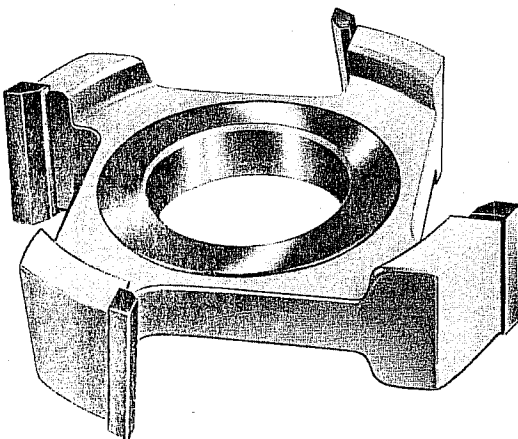

<u>Dia.</u>	<u>Ancho</u>	<u>Eje</u>	<u>HSS</u>	<u>MD</u>
120	20	30	<b>105,38</b>	<b>107,55 €</b>
120	30	30	<b>127,33</b>	<b>130,50 €</b>
120	40	30	<b>148,99</b>	<b>153,55 €</b>
120	50	30	<b>170,00</b>	<b>174,30 €</b>
140	20	50	<b>107,85</b>	<b>110,51 €</b>
140	30	50	<b>129,16</b>	<b>133,90 €</b>
140	40	50	<b>152,80</b>	<b>157,90 €</b>
140	50	50	<b>174,26</b>	<b>179,65 €</b>

**121 FRESA GALCES**

**4 cortes rectos**

**MEC- ALIMENTACION MECANICA**

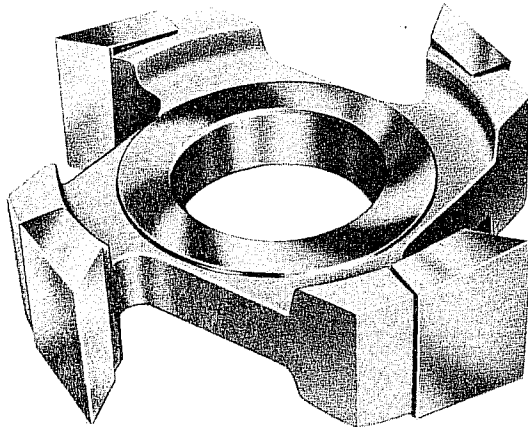

<u>Dia.</u>	<u>Ancho</u>	<u>Eje</u>	<u>HSS</u>
120	20	30	<b>90,60 €</b>
120	30	30	<b>102,11 €</b>
120	40	30	<b>112,15 €</b>
120	50	30	<b>129,80 €</b>
140	20	50	<b>93,02 €</b>
140	30	50	<b>104,99 €</b>
140	40	50	<b>120,90 €</b>
140	50	50	<b>137,50 €</b>

**122 FRESA GALCES**

**4 Z alt + 4 prec.**

**MEC- ALIMENTACION MECANICA**

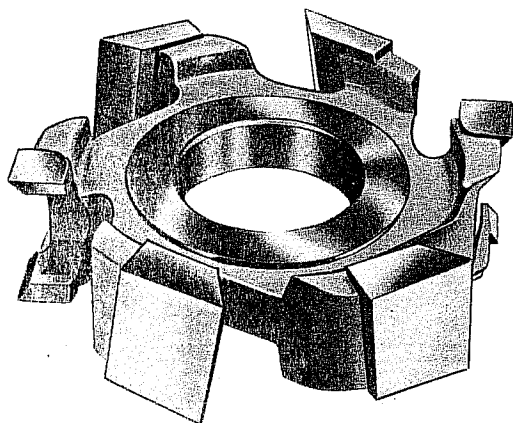

<u>Dia.</u>	<u>Ancho</u>	<u>Eje</u>	<u>HSS</u>	<u>MD</u>
120	20	30	<b>151,77</b>	<b>163,20 €</b>
120	30	30	<b>172,10</b>	<b>186,10 €</b>
120	40	30	<b>194,80</b>	<b>211,20 €</b>
120	50	30	<b>222,70</b>	<b>245,90 €</b>
140	20	50	<b>155,40</b>	<b>165,40 €</b>
140	30	50	<b>176,40</b>	<b>191,45 €</b>
140	40	50	<b>202,40</b>	<b>220,15 €</b>
140	50	50	<b>229,40</b>	<b>249,50 €</b>

**130 JUEGO FRESAS GALGES Y RANURAS**

**4Z alterno + 4 prec.**

**MEC- ALIMENTACION MECANICA**

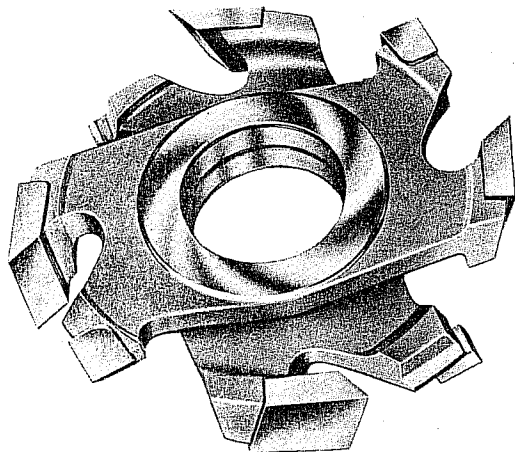

Dia.	Ancho	Eje	HSS	MD
120	15/29,5	30	<b>231,90</b>	<b>253,75 €</b>
120	30x59,5	30	<b>272,22</b>	<b>294,99 €</b>
140	15/29,5	50	<b>235,22</b>	<b>254,95 €</b>
140	20/39,5	50	<b>254,88</b>	<b>276,00 €</b>
140	30/59,5	50	<b>274,51</b>	<b>297,50 €</b>
160	15/29,5	50	<b>236,37</b>	<b>257,20 €</b>
160	20/39,5	50	<b>256,55</b>	<b>277,99 €</b>
160	30/59,5	50	<b>276,69</b>	<b>299,99 €</b>

Se suministra con 1 juego de anillos decimales

**140 FRESA PERFIL DE BISEL**

**MEC- ALIMENTACION MECANICA**

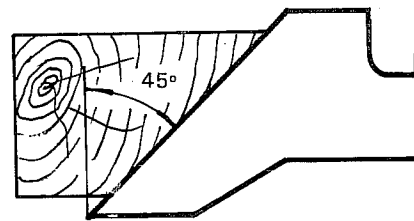
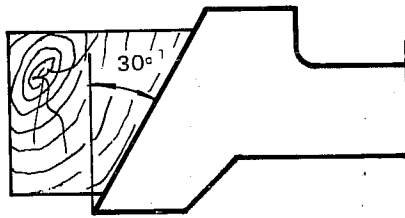
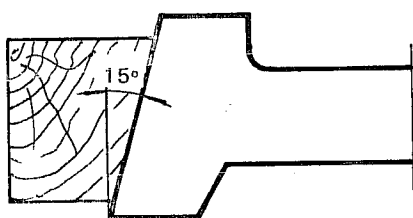

4 cortes. Ancho de 26 mm.

Bisel	Dia.	Eje	HSS	MD
15°	120	30	<b>161,98</b>	<b>170,50 €</b>
15°	140	50	<b>167,01</b>	<b>175,80 €</b>
30°	120	30	<b>161,98</b>	<b>170,50 €</b>
30°	140	50	<b>167,01</b>	<b>175,80 €</b>
45°	140	30	<b>167,01</b>	<b>175,80 €</b>
45°	160	50	<b>171,95</b>	<b>181,00 €</b>

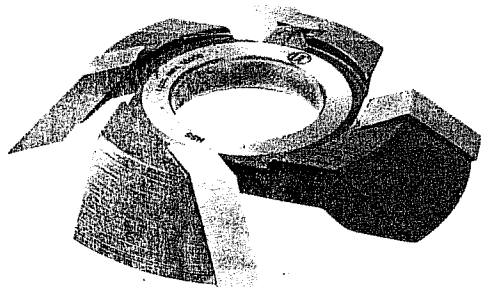

Precio de la fresa de 45° en las dos posiciones de trabajo.

**140 TARIFA FRESAS ESPECIALES PERFILES DE BISEL****4 CORTES****MEC- ALIMENTACION MECANICA**

DIÁMETRO		120	130	140	150	160	170	180 mm.
Ancho hasta 10 mm.	HSS	<b>143,79</b>	<b>145,86</b>	<b>147,88</b>	<b>149,99</b>	<b>152,02</b>	<b>154,62</b>	<b>156,12 €</b>
	MD	<b>151,36</b>	<b>153,54</b>	<b>155,66</b>	<b>157,88</b>	<b>160,02</b>	<b>162,76</b>	<b>164,34 €</b>
Ancho 11 a 20 mm.	HSS	<b>169,60</b>	<b>171,93</b>	<b>174,14</b>	<b>175,07</b>	<b>177,42</b>	<b>179,85</b>	<b>182,23 €</b>
	MD	<b>178,53</b>	<b>180,98</b>	<b>183,31</b>	<b>184,28</b>	<b>186,76</b>	<b>189,32</b>	<b>191,83 €</b>
Ancho 21 a 30 mm.	HSS	<b>202,47</b>	<b>203,63</b>	<b>206,68</b>	<b>209,91</b>	<b>213,06</b>	<b>216,18</b>	<b>219,34 €</b>
	MD	<b>210,91</b>	<b>214,35</b>	<b>217,56</b>	<b>220,96</b>	<b>224,27</b>	<b>227,56</b>	<b>230,88 €</b>
Ancho 31 a 40 mm.	HSS	<b>232,16</b>	<b>236,04</b>	<b>239,92</b>	<b>243,79</b>	<b>247,63</b>	<b>251,52</b>	<b>255,39 €</b>
	MD	<b>244,38</b>	<b>248,46</b>	<b>252,55</b>	<b>256,62</b>	<b>260,66</b>	<b>264,76</b>	<b>268,83 €</b>
Ancho 41 a 50 mm.	HSS	<b>262,91</b>	<b>267,46</b>	<b>272,02</b>	<b>276,62</b>	<b>283,53</b>	<b>285,74</b>	<b>290,34 €</b>
	MD	<b>276,75</b>	<b>281,54</b>	<b>286,34</b>	<b>291,18</b>	<b>298,45</b>	<b>300,78</b>	<b>305,62 €</b>
Ancho 51 a 60 mm.	HSS	<b>294,09</b>	<b>299,34</b>	<b>304,65</b>	<b>309,82</b>	<b>315,21</b>	<b>320,47</b>	<b>325,72 €</b>
	MD	<b>309,57</b>	<b>315,10</b>	<b>320,68</b>	<b>326,13</b>	<b>331,80</b>	<b>337,34</b>	<b>342,86 €</b>

FRESAS DE 3 CORTES – DESCUENTO 10%  
 FRESAS DE 2 CORTES – DESCUENTO 20%

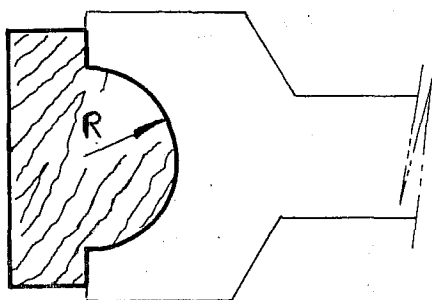
**MEC- ALIMENTACION MECANICA**

<b>Radio</b>	<b>Diám.</b>	<b>Agujero</b>	<b>HSS</b>	<b>MD</b>
4	120	30	<b>160,00</b>	<b>190,20 €</b>
	140	50	<b>163,10</b>	<b>193,70 €</b>
5	120	30	<b>162,30</b>	<b>190,90 €</b>
	140	50	<b>165,70</b>	<b>194,10 €</b>
6	120	30	<b>195,70</b>	<b>231,15 €</b>
	140	50	<b>199,20</b>	<b>235,20 €</b>
8	120	30	<b>196,10</b>	<b>231,80 €</b>
	140	50	<b>200,00</b>	<b>236,10 €</b>
10	120	30	<b>225,90</b>	<b>271,90 €</b>
	140	50	<b>229,45</b>	<b>276,20 €</b>
12	120	30	<b>234,60</b>	<b>275,50 €</b>
	140	50	<b>239,50</b>	<b>280,40 €</b>
15	120	30	<b>295,30</b>	<b>343,90 €</b>
	140	50	<b>299,99</b>	<b>349,90 €</b>

**161 FRESA ½ CIRCULO CONVEXO****4 CORTES****MEC- ALIMENTACION MECANICA**

<b>Radio</b>	<b>Diám.</b>	<b>Agujero</b>	<b>HSS</b>	<b>MD</b>
3	120	30	<b>121,20</b>	<b>149,08 €</b>
	140	50	<b>124,10</b>	<b>152,10 €</b>
4	120	30	<b>121,20</b>	<b>149,08 €</b>
	140	50	<b>124,10</b>	<b>152,10 €</b>
5	120	30	<b>121,20</b>	<b>149,08 €</b>
	140	50	<b>124,10</b>	<b>152,10 €</b>
6	120	30	<b>155,50</b>	<b>189,90 €</b>
	140	50	<b>159,40</b>	<b>193,10 €</b>
7,5	120	30	<b>158,80</b>	<b>195,30 €</b>
	140	50	<b>162,80</b>	<b>199,20 €</b>
8	120	30	<b>158,80</b>	<b>195,30 €</b>
	140	50	<b>162,80</b>	<b>199,20 €</b>
10	120	30	<b>165,90</b>	<b>199,70 €</b>
	140	50	<b>169,10</b>	<b>203,90 €</b>
12	120	30	<b>176,50</b>	<b>226,60 €</b>
	140	50	<b>180,70</b>	<b>230,10 €</b>
15	120	30	<b>205,80</b>	<b>261,90 €</b>
	140	50	<b>210,90</b>	<b>266,80 €</b>

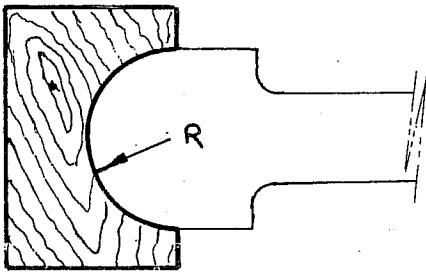

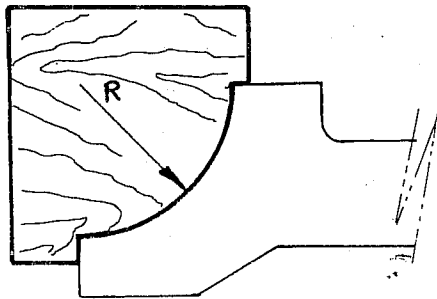
**162 FRESA 1/4 CIRCULO RADIO CONCAVO****4 CORTES****MEC- ALIMENTACION MECANICA**

<b>Radio</b>	<b>Diám.</b>	<b>Agujero</b>	<b>HSS</b>	<b>MD</b>
3	120	30	<b>156,90</b>	<b>188,20 €</b>
	140	50	<b>159,80</b>	<b>191,30 €</b>
4	120	30	<b>156,90</b>	<b>188,20 €</b>
	140	50	<b>159,80</b>	<b>191,30 €</b>
5	120	30	<b>156,90</b>	<b>188,20 €</b>
	140	50	<b>159,80</b>	<b>191,30 €</b>
6	120	30	<b>158,40</b>	<b>190,60 €</b>
	140	50	<b>161,30</b>	<b>193,90 €</b>
8	120	30	<b>159,20</b>	<b>191,00 €</b>
	140	50	<b>162,10</b>	<b>194,10 €</b>
10	120	30	<b>159,20</b>	<b>191,00 €</b>
	140	50	<b>162,10</b>	<b>194,10 €</b>
12	120	30	<b>161,80</b>	<b>194,90 €</b>
	140	50	<b>165,50</b>	<b>198,40 €</b>
15	120	30	<b>187,90</b>	<b>234,80 €</b>
	140	50	<b>191,80</b>	<b>238,70 €</b>
20	130	30	<b>189,80</b>	<b>235,70 €</b>
	150	50	<b>193,90</b>	<b>240,90 €</b>
25	140	30	<b>224,70</b>	<b>320,90 €</b>
	160	50	<b>228,90</b>	<b>325,00 €</b>
30	170	50	<b>289,90</b>	<b>369,30 €</b>
35	190	50	<b>355,90</b>	<b>459,60 €</b>
40	200	50	<b>389,80</b>	<b>499,60 €</b>

**163 FRESA ¼ CIRCULO RADIO CONVEXO**

**4 CORTES**

**MEC- ALIMENTACION MECANICA**

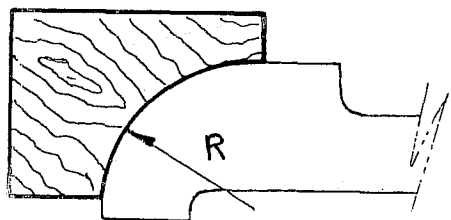

Radio	Diám.	Agujero	HSS	MD
5	120	30	<b>147,00</b>	<b>184,20 €</b>
	140	50	<b>150,10</b>	<b>187,10 €</b>
8	120	30	<b>150,00</b>	<b>186,80 €</b>
	140	50	<b>153,20</b>	<b>190,10 €</b>
10	120	30	<b>153,30</b>	<b>190,50 €</b>
	140	50	<b>156,50</b>	<b>194,80 €</b>
12	120	30	<b>153,30</b>	<b>190,50 €</b>
	140	50	<b>156,50</b>	<b>194,80 €</b>
15	120	30	<b>155,60</b>	<b>196,00 €</b>
	140	50	<b>158,90</b>	<b>199,40 €</b>
20	130	30	<b>156,90</b>	<b>197,60 €</b>
	150	50	<b>160,30</b>	<b>201,40 €</b>
25	140	30	<b>199,10</b>	<b>262,30 €</b>
	160	50	<b>201,50</b>	<b>265,80 €</b>

**165 FRESA PERFIL ESPECIAL – HASTA 20 FP****4 CORTES****MEC- ALIMENTACION MECANICA**

Profundidad de perfil hasta 20 mm.

Diámetro		120	140	160	180	200 mm.
Ancho hasta 10 mm.	HSS	189,60	193,70	199,30	203,70	208,20 €
	MD	205,60	213,30	209,30	219,80	229,30 €
Ancho 11/20 mm.	HSS	211,60	215,90	221,90	228,00	234,20 €
	MD	236,00	241,30	245,40	249,50	261,90 €
Ancho 21/30 mm.	HSS	238,00	242,30	246,60	250,90	258,70 €
	MD	272,00	278,50	288,00	292,10	296,20 €
Ancho 31/40 mm.	HSS	282,40	287,30	293,50	298,80	306,00 €
	MD	287,90	296,60	305,50	311,80	348,30 €
Ancho 41/50 mm.	HSS	297,80	306,10	313,00	316,50	320,20 €
	MD	324,70	331,30	339,45	344,80	385,70 €
Ancho 51/60 mm.	HSS	316,40	325,60	338,10	347,80	357,50 €
	MD	389,30	397,90	406,50	415,10	428,70 €
Ancho 61/70 mm.	HSS	330,70	341,90	348,00	354,10	375,70 €
	MD	417,00	426,50	435,90	445,30	463,30 €
Ancho 71/80 mm.	HSS	346,40	356,50	365,90	375,20	382,10 €
	MD	441,30	451,80	462,35	472,90	501,00 €
Ancho 81/90 mm.	HSS	364,80	373,50	383,60	393,60	400,60 €
	MD	461,50	477,00	493,20	509,40	527,20 €
Ancho 91/100 mm.	HSS	386,50	393,10	403,90	414,80	421,60 €
	MD	498,20	515,30	532,40	549,20	577,50 €

FRESA DE 2 CORTES – DESCUENTO 20 %  
 FRESA DE 3 CORTES – DESCUENTO 10 %

FRESA DE 6 CORTES – AUMENTO 25 %  
 FRESA DE 8 CORTES – AUMENTO 45 %

<b>165 FRESA PERFIL ESPECIAL – SUPERIOR 20 FP</b>	<b>4 CORTES</b>
---	-----------------

**MEC- ALIMENTACION MECANICA**

Profundidad de perfil superior a 20 mm.  
Diámetro exterior máximo: 220 mm.

Profundidad de perfil		21/30	31/40	41/50	51/60 mm.
Ancho hasta 20 mm.	HSS	<b>233,90</b>	<b>259,30</b>	<b>269,50</b>	<b>280,50 €</b>
	MD	<b>296,10</b>	<b>317,00</b>	<b>328,20</b>	<b>340,50 €</b>
Ancho 21/30 mm.	HSS	<b>279,80</b>	<b>290,50</b>	<b>304,50</b>	<b>319,10 €</b>
	MD	<b>331,60</b>	<b>364,20</b>	<b>396,50</b>	<b>436,60 €</b>
Ancho 31/40 mm.	HSS	<b>305,50</b>	<b>311,80</b>	<b>320,00</b>	<b>330,20 €</b>
	MD	<b>367,70</b>	<b>423,60</b>	<b>478,30</b>	<b>529,90 €</b>
Ancho 41/50 mm.	HSS	<b>320,50</b>	<b>331,40</b>	<b>342,60</b>	<b>359,50 €</b>
	MD	<b>427,60</b>	<b>497,30</b>	<b>562,60</b>	<b>621,60 €</b>
Ancho 51/60 mm.	HSS	<b>347,90</b>	<b>358,20</b>	<b>368,00</b>	<b>394,50 €</b>
	MD	<b>493,00</b>	<b>574,20</b>	<b>639,70</b>	<b>718,50 €</b>
Ancho 61/70 mm.	HSS	<b>368,50</b>	<b>401,00</b>	<b>442,20</b>	<b>479,00 €</b>
	MD	<b>613,10</b>	<b>709,10</b>	<b>807,10</b>	<b>900,90 €</b>
Ancho 71/80 mm.	HSS	<b>390,90</b>	<b>439,90</b>	<b>482,50</b>	<b>525,50 €</b>
	MD	<b>663,20</b>	<b>782,10</b>	<b>887,40</b>	<b>990,60 €</b>
Ancho 81/90 mm.	HSS	<b>424,90</b>	<b>473,80</b>	<b>522,20</b>	<b>570,50 €</b>
	MD	<b>726,80</b>	<b>854,00</b>	<b>973,90</b>	<b>1.085,50 €</b>
Ancho 91/100 mm.	HSS	<b>458,90</b>	<b>507,40</b>	<b>563,00</b>	<b>616,70 €</b>
	MD	<b>791,40</b>	<b>924,90</b>	<b>1.061,50</b>	<b>1.180,40 €</b>

FRESA DE 2 CORTES – DESCUENTO	20 %
FRESA DE 3 CORTES – DESCUENTO	10 %
FRESA DE 6 CORTES – AUMENTO	25 %
FRESA DE 8 CORTES – AUMENTO	45 %

**165 MOLDURAS**

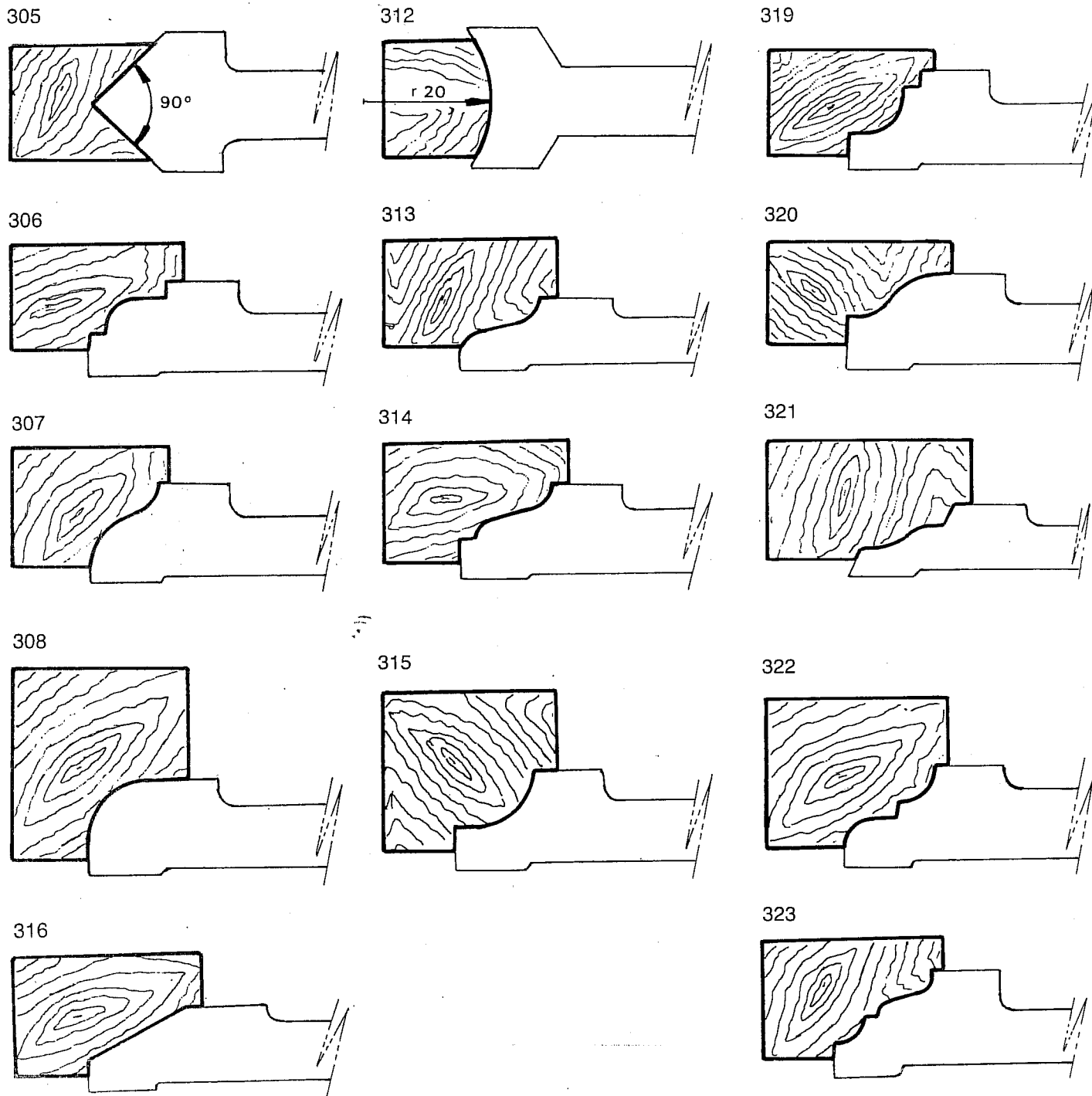

**4 cortes**

Perfil nº	Diámetro Agujero		HSS	MD
305 y 312	140	50	<b>210,50</b>	<b>232,50 €</b>
306-307-308-313-314-315 316-319-320-321-322	140	50	<b>215,90</b>	<b>241,30 €</b>
323	150	50	<b>221,90</b>	<b>245,40 €</b>

**165 MOLDURAS**

310

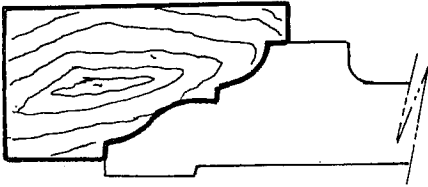

311

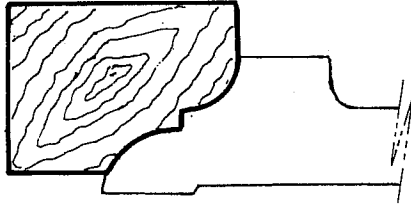

317

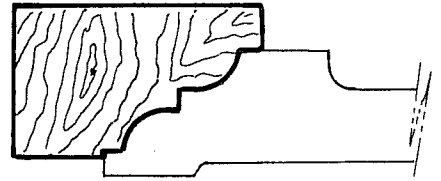

318

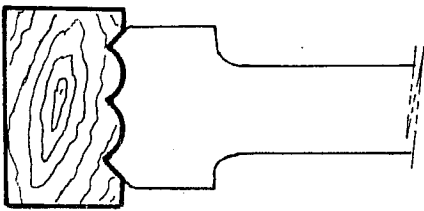

325

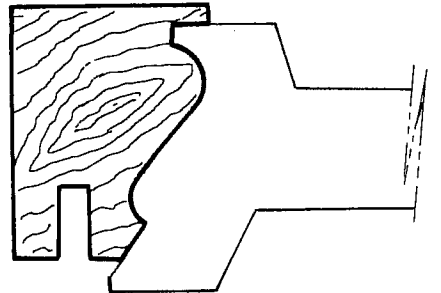

326

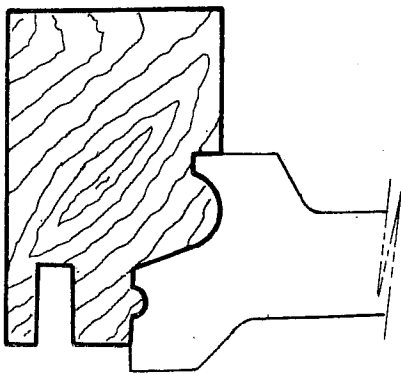

330

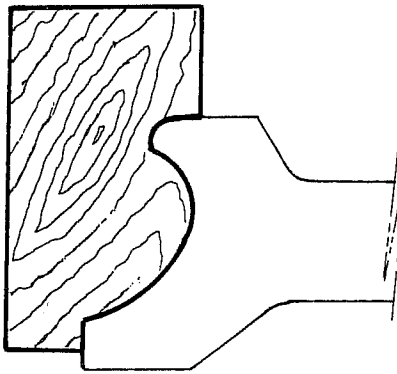

333

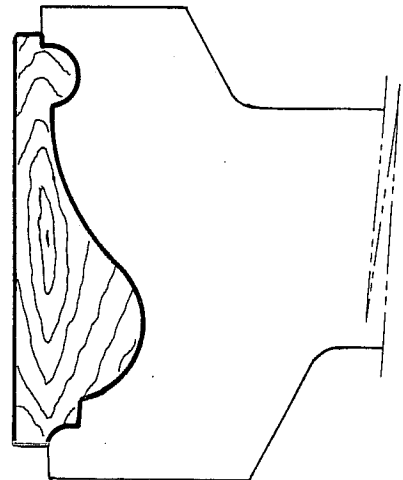

**4 cortes**

Perfil n°	310	311	317	318	325	326	330	333
Diámetro	150	150	150	140	140	140	140	140 mm.
Agujero	50	50	50	50	50	50	50	50 mm.

HSS	221,90	221,90	221,90	215,90	287,30	242,30	287,30	325,60 €
MD	245,40	245,40	245,40	241,30	296,60	278,50	296,60	397,90 €

**165 MOLDURAS**

327

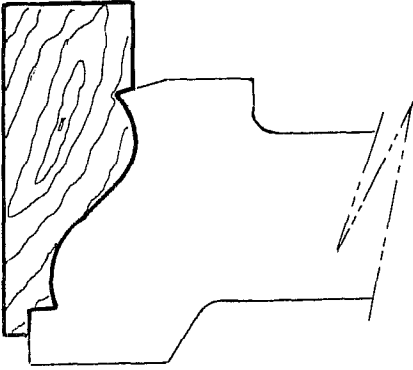

331

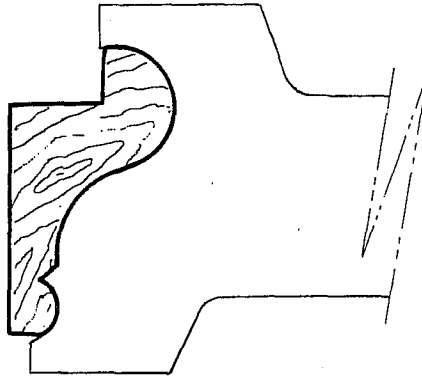

334

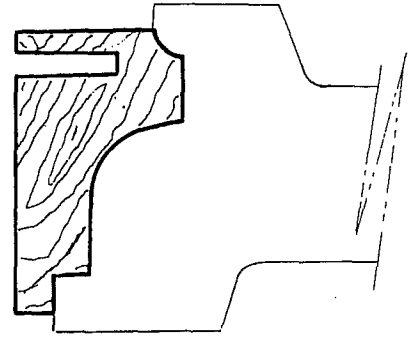

328

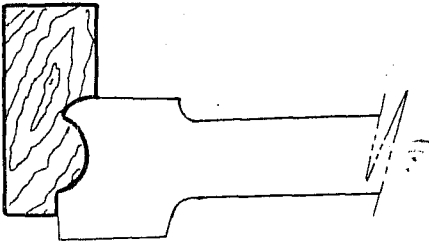

332

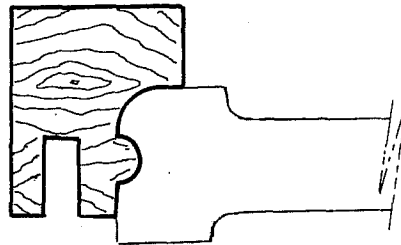

335

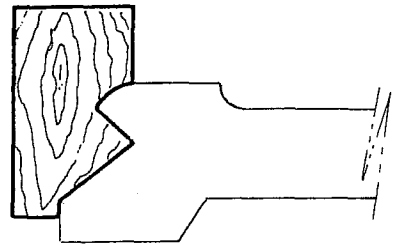

329

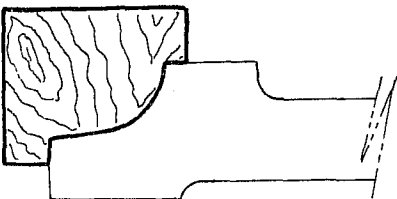

336

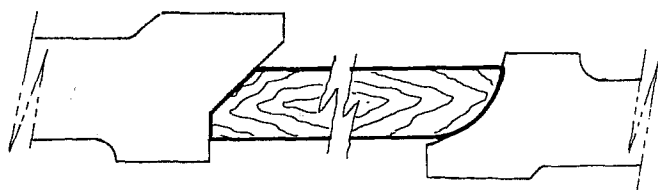

337

**4 cortes**

Perfil nº	327	328	329	331	332	334	335	336	337
Diámetro	140	140	140	150	140	150	140	140	140 mm.
Agujero	50	50	50	50	50	50	50	50	50 mm.

HSS  
MD

<b>287,30</b>	<b>215,90</b>	<b>215,90</b>	<b>313,00</b>	<b>215,90</b>	<b>313,00</b>	<b>215,90</b>	<b>215,90</b>	<b>215,90</b>	<b>215,90 €</b>
<b>296,60</b>	<b>241,30</b>	<b>241,30</b>	<b>339,45</b>	<b>241,30</b>	<b>339,45</b>	<b>241,30</b>	<b>241,30</b>	<b>241,30 €</b>	

**165 CIERRE PUERTAS Y VENTANAS**

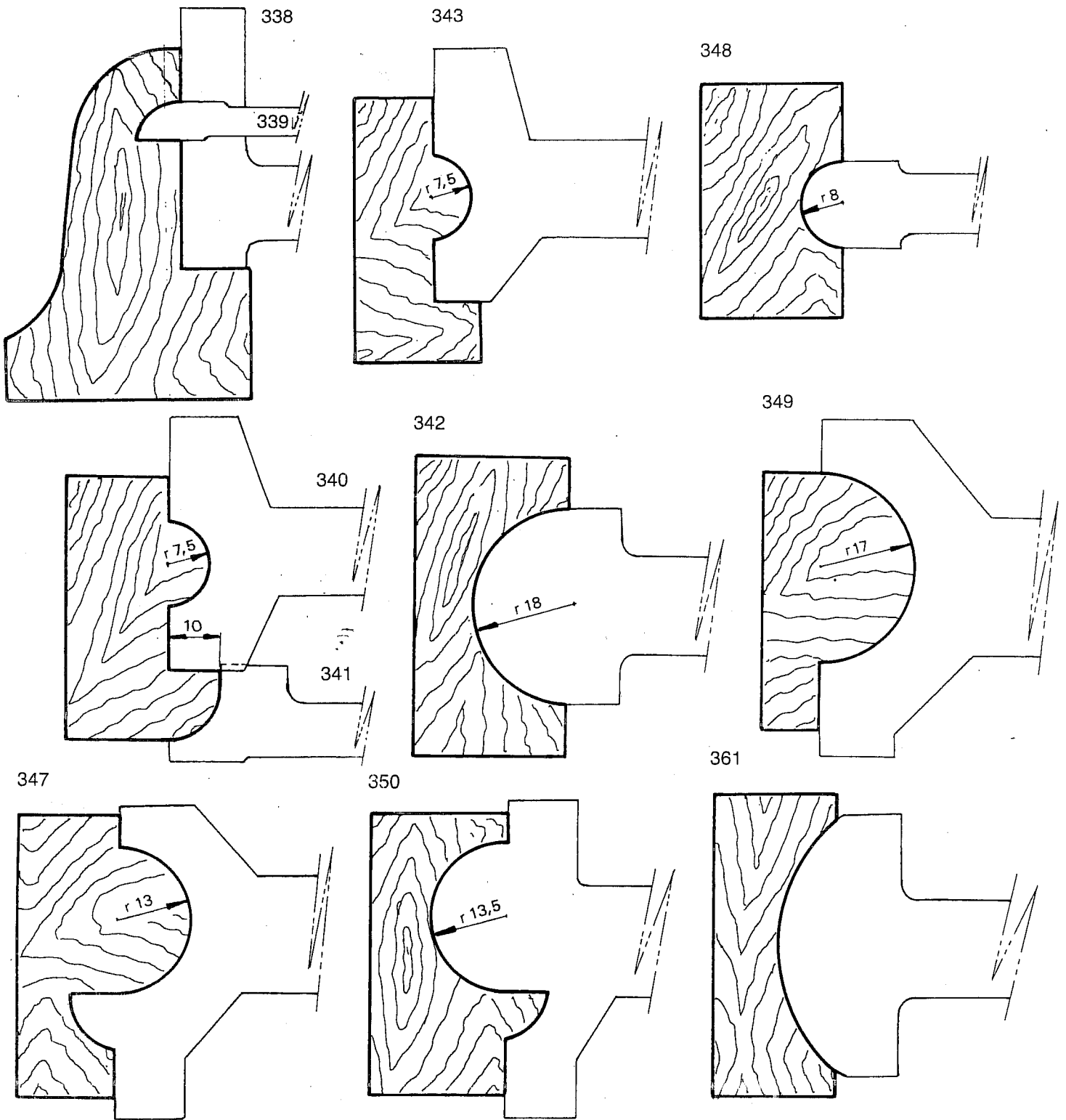

**4 cortes**

Perfil nº	338	339	340	341	342	343	347	348	349	361
Diámetro	140	156	140	140	150	140	150	140	150	140 mm.
Agujero	50	50	50	50	50	50	50	50	50	50 mm.

HSS	236,04	199,30	306,10	215,90	293,50	306,10	338,10	162,80	338,10	306,10 €
MD	248,50	209,30	331,30	241,30	305,50	331,30	406,50	199,20	406,50	331,30 €

**165 JUNQUILLOS**

368

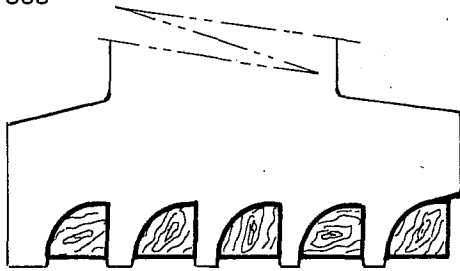

375

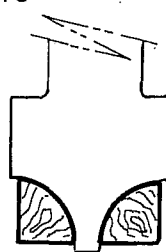

380

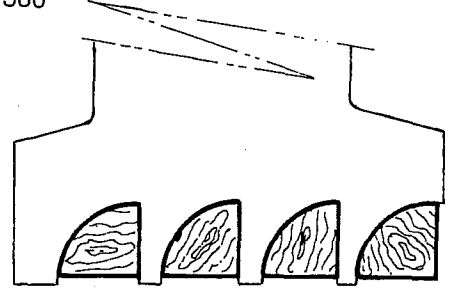

369

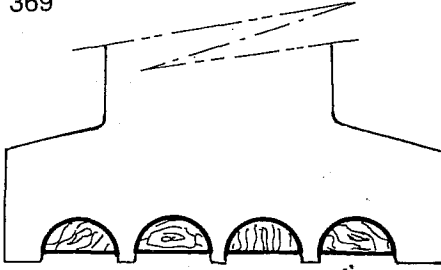

376

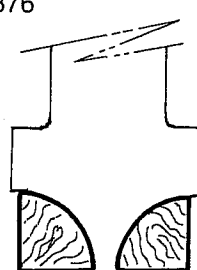

381

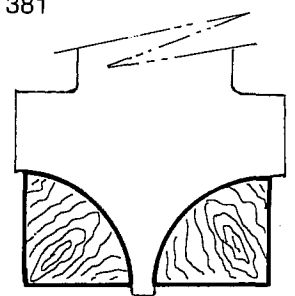

370

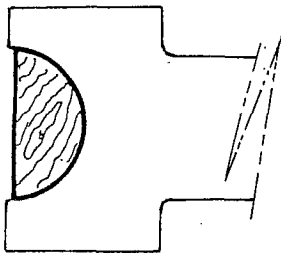

371

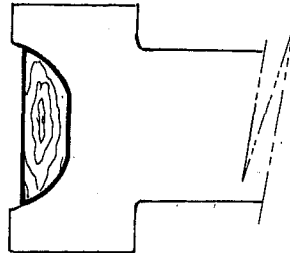

377

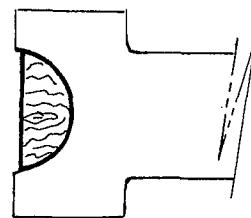

382

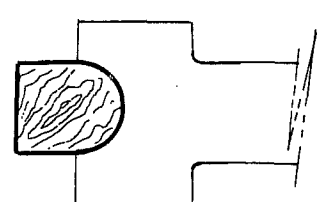

**4 cortes**

Perfil nº	368	369	370	371	375	376	377	380	381	382
Diámetro	140	140	140	140	140	140	140	140	140	140
Agujero	50	50	50	50	50	50	50	50	50	50

HSS	325,60	325,60	242,30	242,30	215,90	242,30	242,30	325,60	287,30	242,30€
MD	397,90	397,90	278,50	278,50	241,30	278,50	278,50	397,90	296,60	278,50€

**165 JUNQUILLOS**

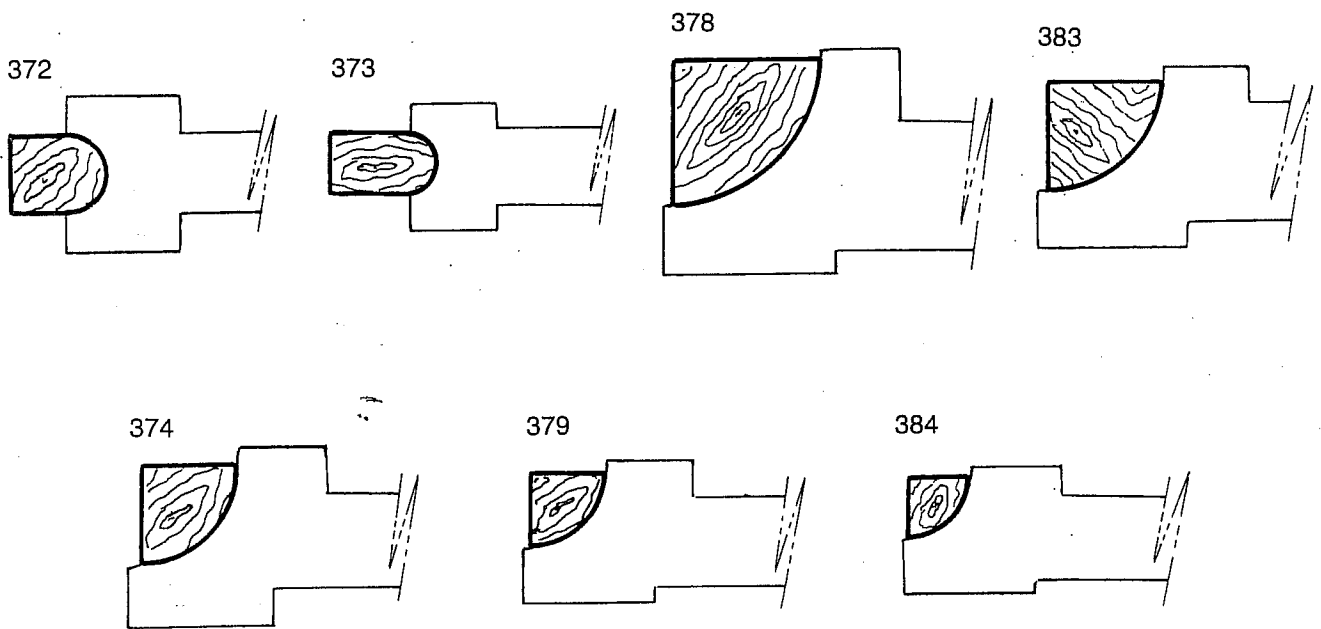

**4 cortes**

Perfil nº	372	373	374	378	379	383	384
Diámetro	140	140	140	150	140	140	140 mm.
Agujero	50	50	50	50	50	50	50 mm.

HSS	<b>215,90</b>	<b>215,90</b>	<b>242,30</b>	<b>246,60</b>	<b>215,90</b>	<b>242,30</b>	<b>215,90 €</b>
MD	<b>241,30</b>	<b>241,30</b>	<b>278,50</b>	<b>288,00</b>	<b>241,30</b>	<b>278,50</b>	<b>241,30 €</b>

**165 TAPAJUNTAS**

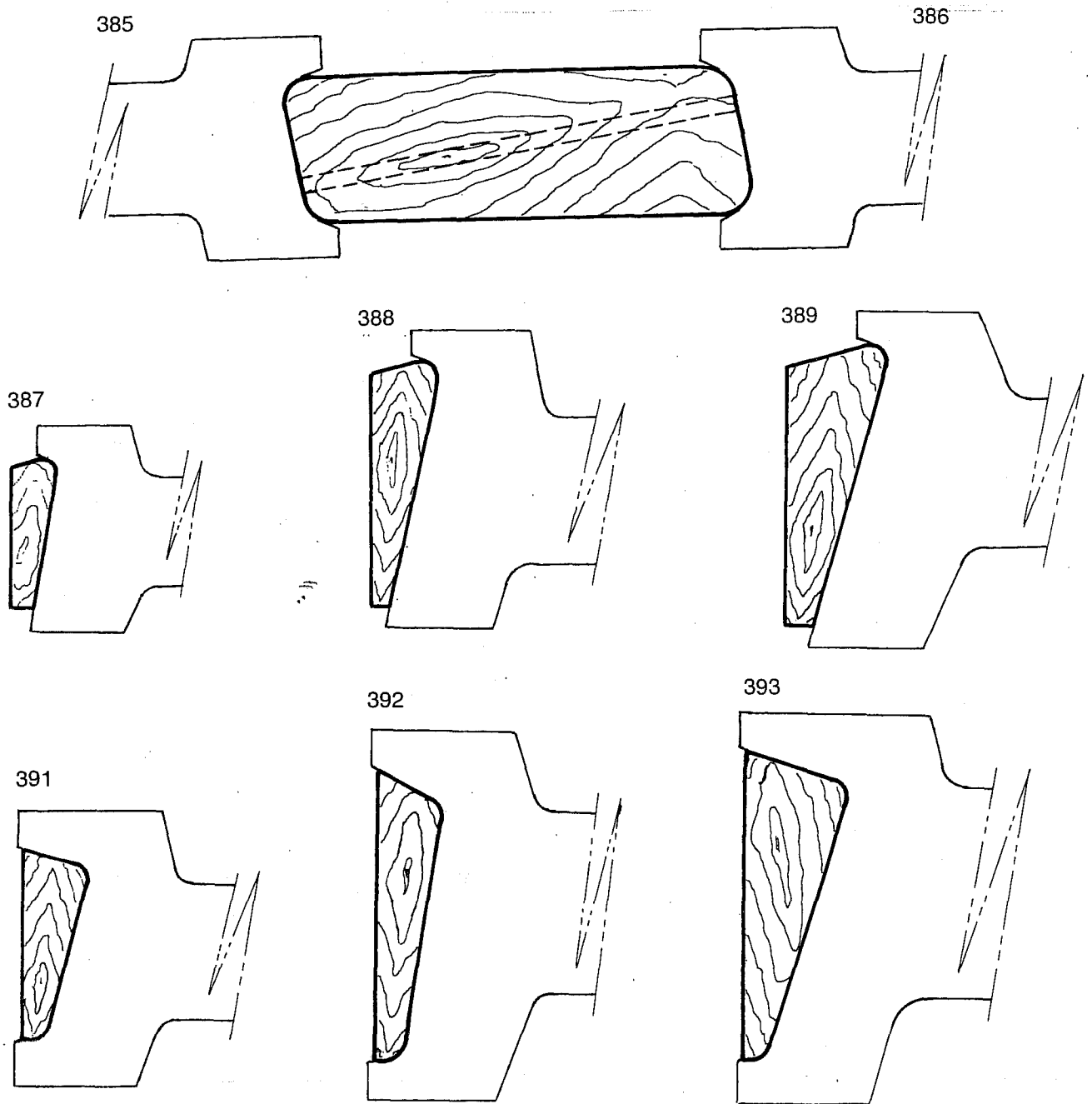

**4 cortes**

Perfil nº	385	386	387	388	389	391	392	393
Diámetro	140	140	140	140	140	140	140	150 mm.
Agujero	50	50	50	50	50	50	50	50 mm.

HSS	287,30	287,30	287,30	306,10	325,60	306,10	325,60	338,10 €
MD	296,60	296,60	296,60	331,30	397,90	331,30	397,90	406,50 €

**165 TAPAJUNTAS**

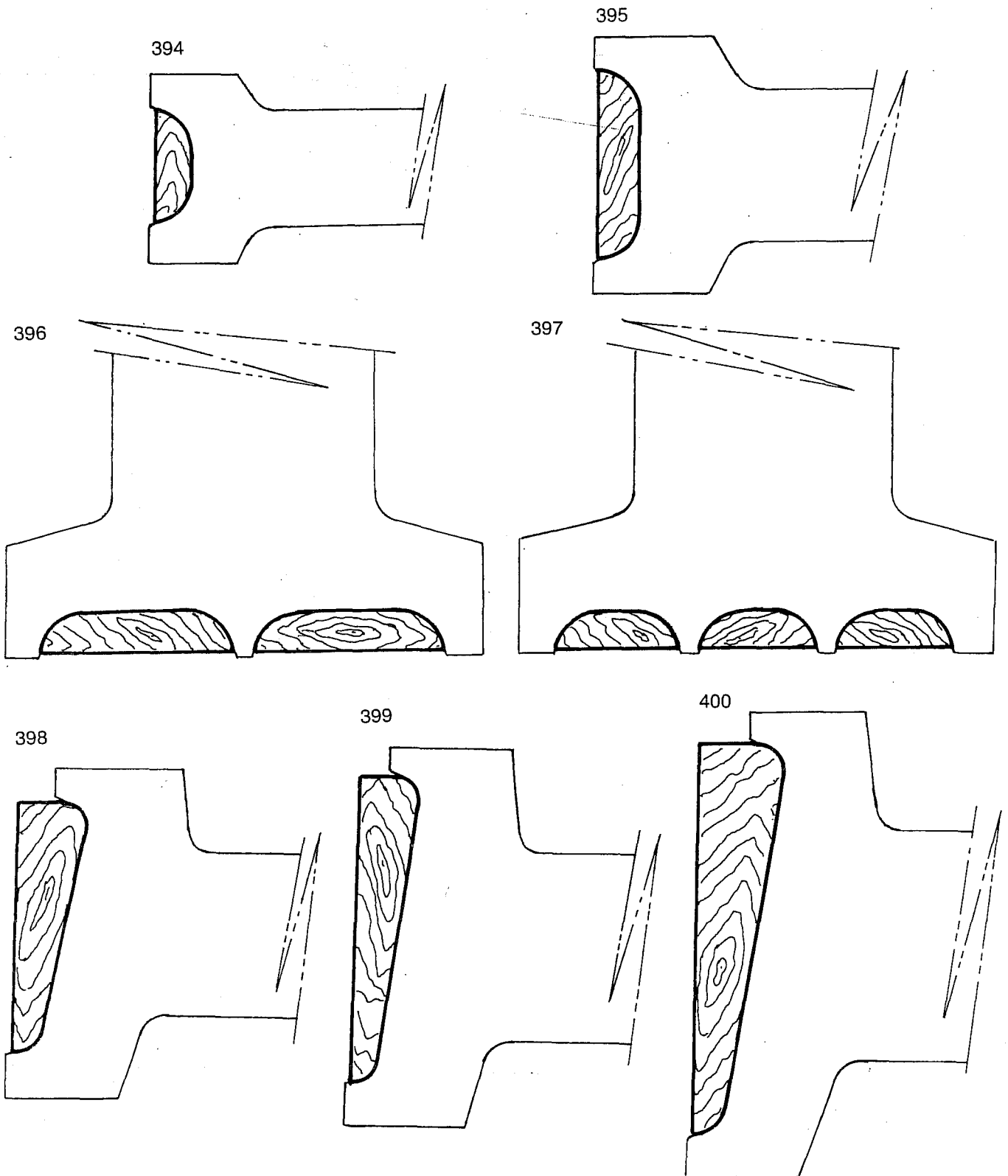

**4 cortes**

Perfil nº	394	395	396	397	398	399	400
Diámetro	140	140	140	140	140	140	150 mm.
Agujero	50	50	50	50	50	50	50 mm.

HSS	287,30	306,10	373,50	373,50	325,60	341,90	383,60 €
MD	296,60	331,30	477,00	477,00	397,90	426,50	493,20 €

**165 TAPAJUNTAS**

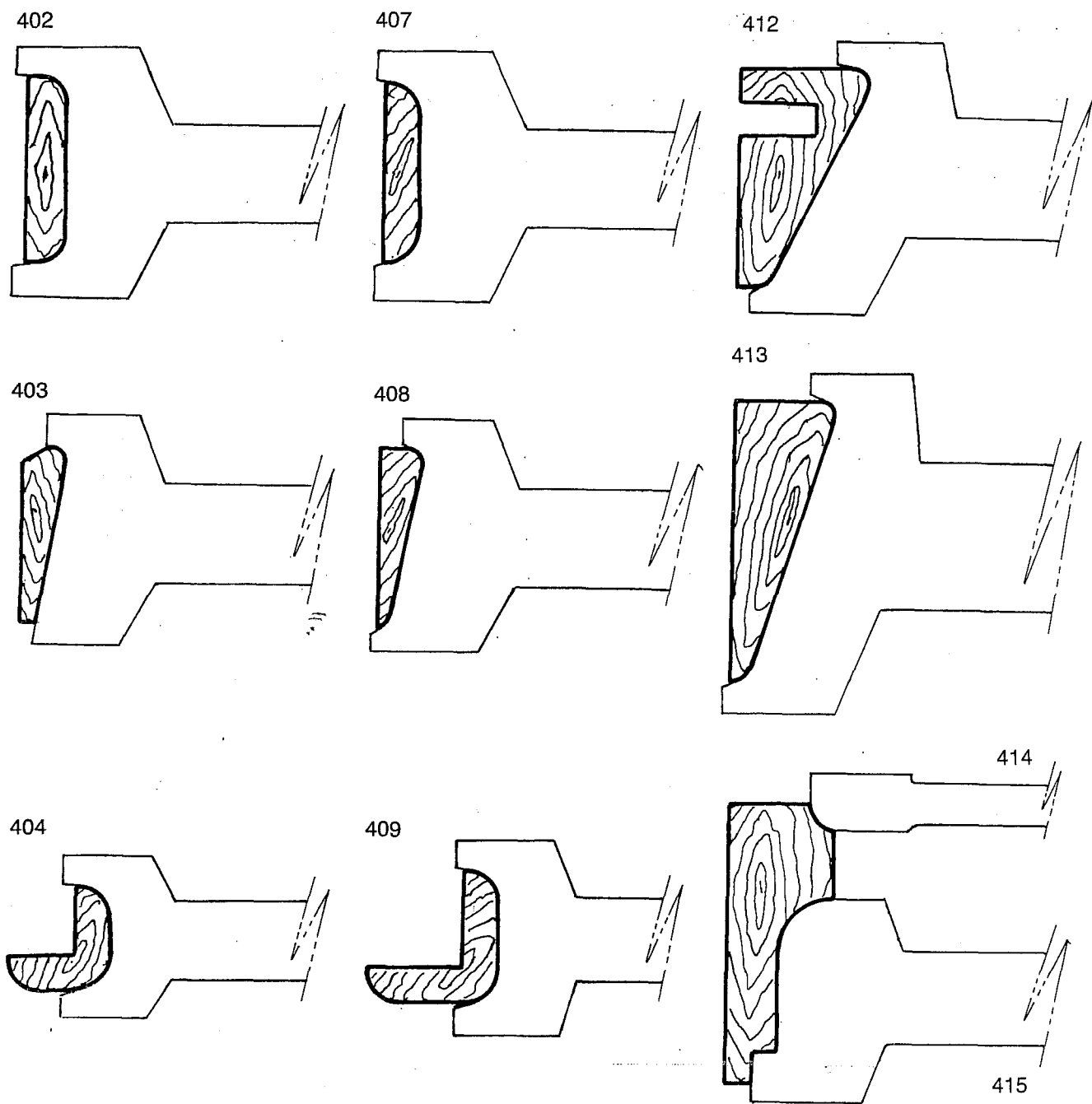

**4 cortes**

Perfil nº	402	403	404	407	408	409	412	413	414	415
Diámetro	140	140	140	140	140	140	150	150	122	140
Agujero	50	50	50	50	50	50	50	50	50	50

HSS	287,30	287,30	242,30	287,30	287,30	242,30	313,00	338,10	193,70	287,30 €
MD	296,60	296,60	278,50	296,60	296,60	278,50	339,45	406,50	213,30	296,60 €

**165 RODILLO PERSIANA - BARRÓN**

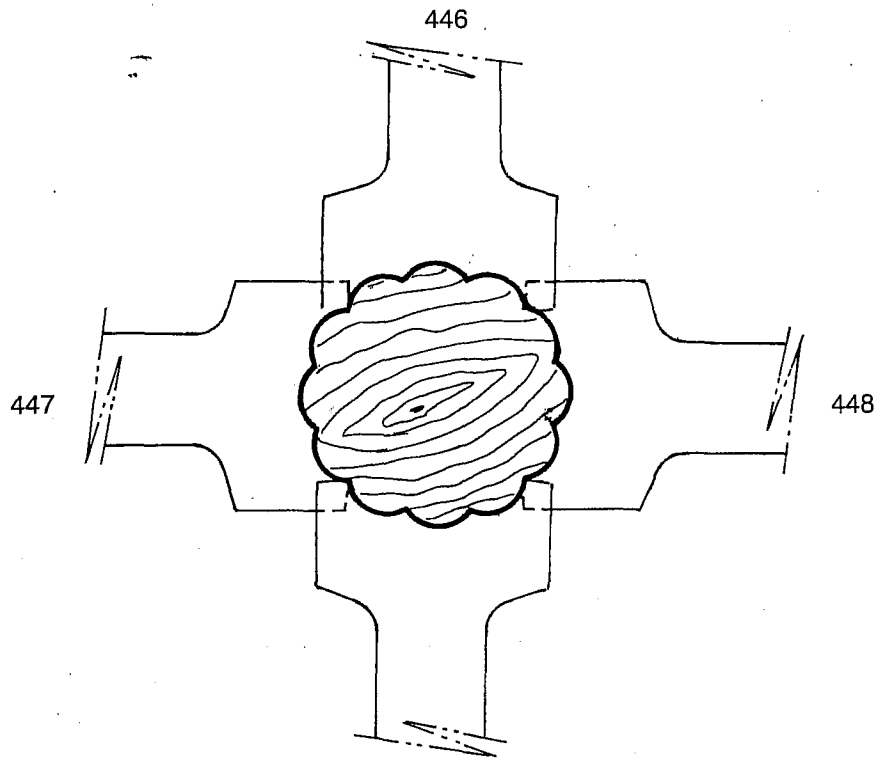
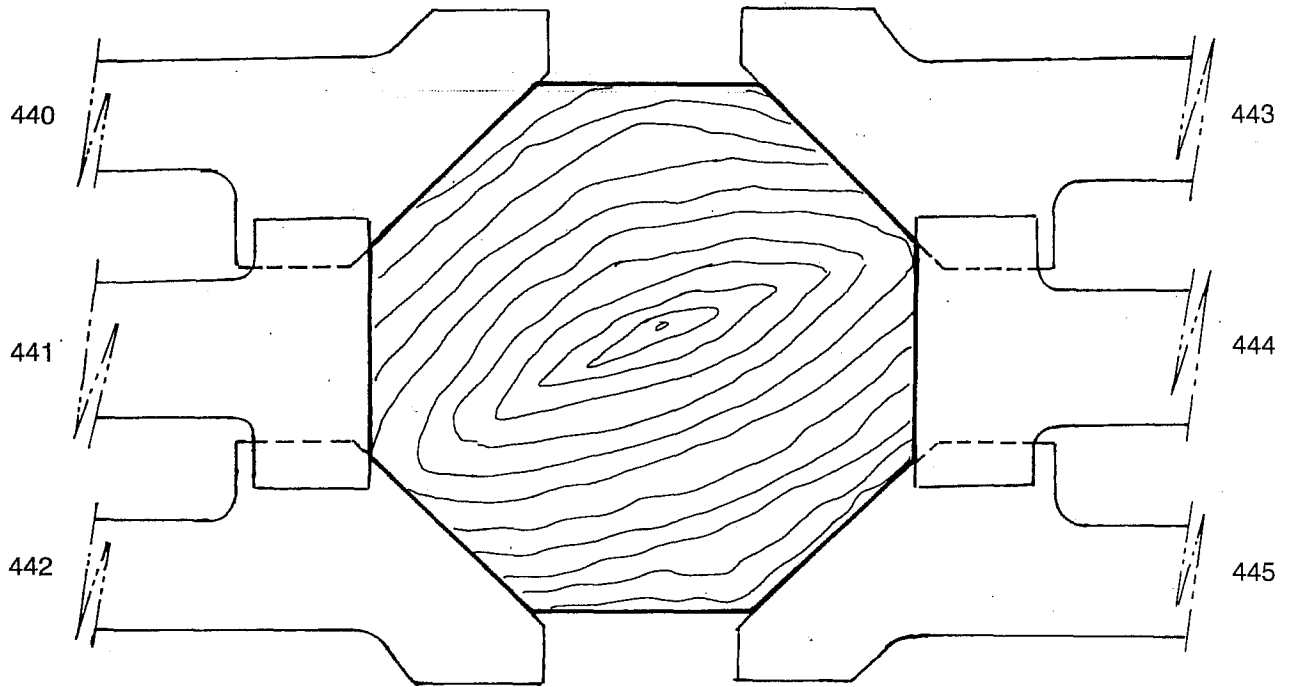

**4 cortes**

	440	441	442	443	444	445	446	447	448	449
Perfil nº	440	441	442	443	444	445	446	447	448	449
Diámetro	160	114	160	160	114	160	140	140	140	140
Agujero	50	50	50	50	50	50	50	50	50	50

HSS	305,50	200,60	305,50	305,50	200,60	305,50	242,30	242,30	242,30	242,30€
MD	367,70	211,20	367,70	367,70	211,20	367,70	278,50	278,50	278,50	278,50€

**165 PALOS REDONDOS**

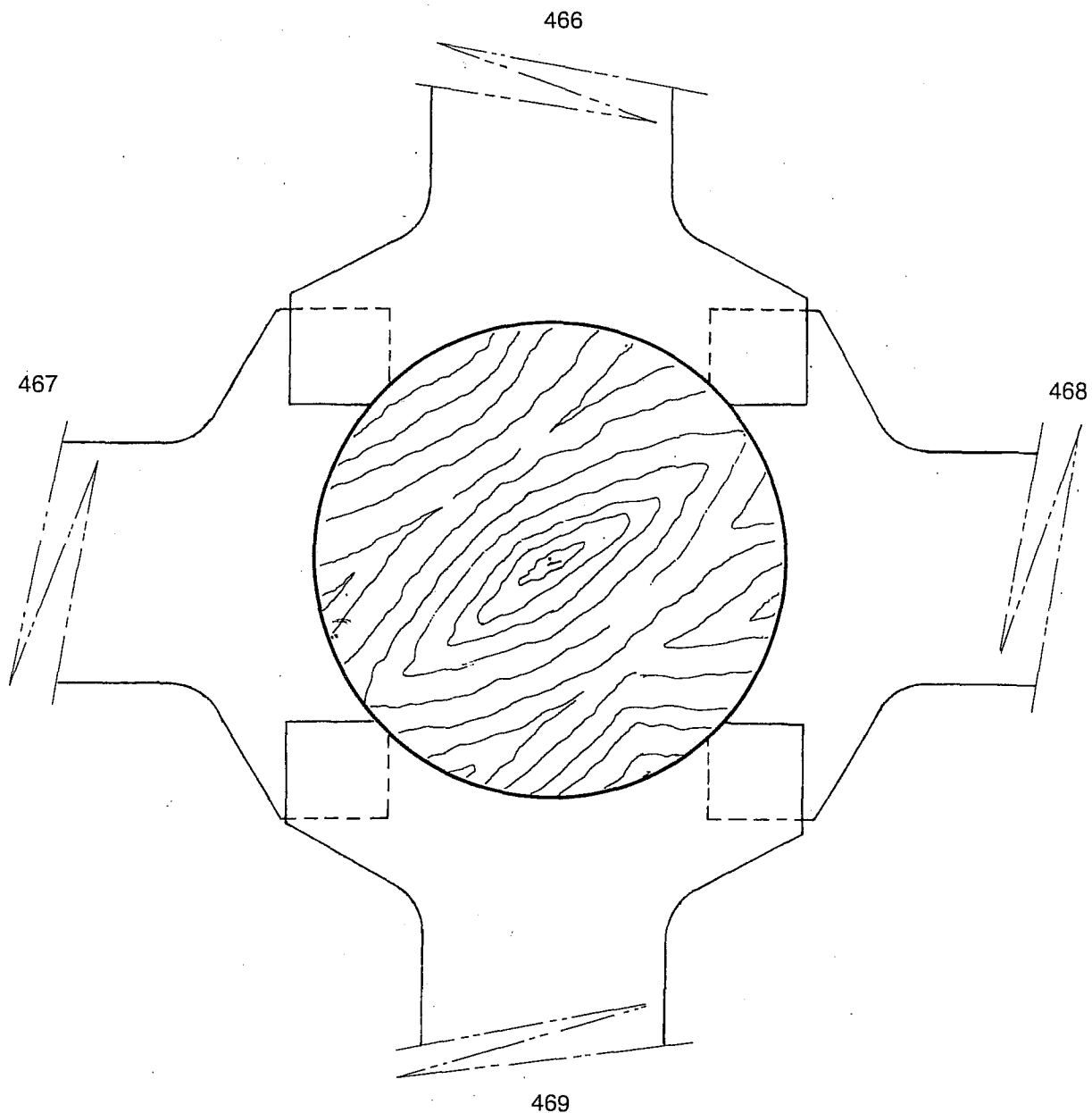

**4 cortes**

	466	467	468	469
Perfil nº	466	467	468	469
Diámetro	140	140	140	140
Agujero	50	50	50	50
HSS	<b>356,50</b>	<b>356,50</b>	<b>356,50</b>	<b>356,50 €</b>
MD	<b>451,80</b>	<b>451,80</b>	<b>451,80</b>	<b>451,80 €</b>

**165 PASAMANOS**

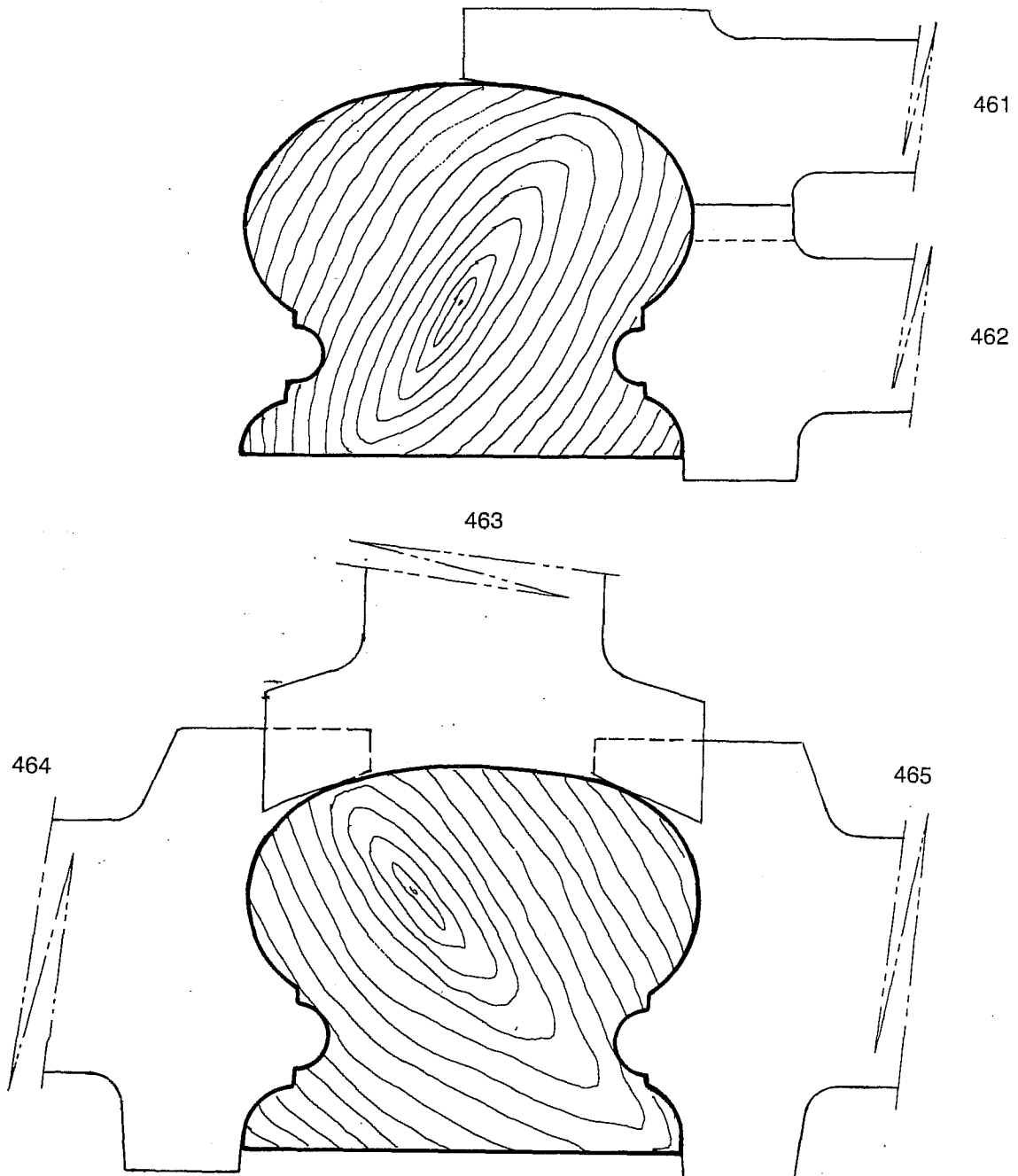

**4 cortes**

Perfil nº	461	462	463	464	465
Díámetro	190	141	140	140	140
Agujero	50	50	50	50	50
HSS	<b>311,80</b>	<b>287,30</b>	<b>341,90</b>	<b>341,90</b>	<b>341,90 €</b>
MD	<b>423,60</b>	<b>296,60</b>	<b>426,50</b>	<b>426,50</b>	<b>426,50 €</b>

**165 PASAMANOS**

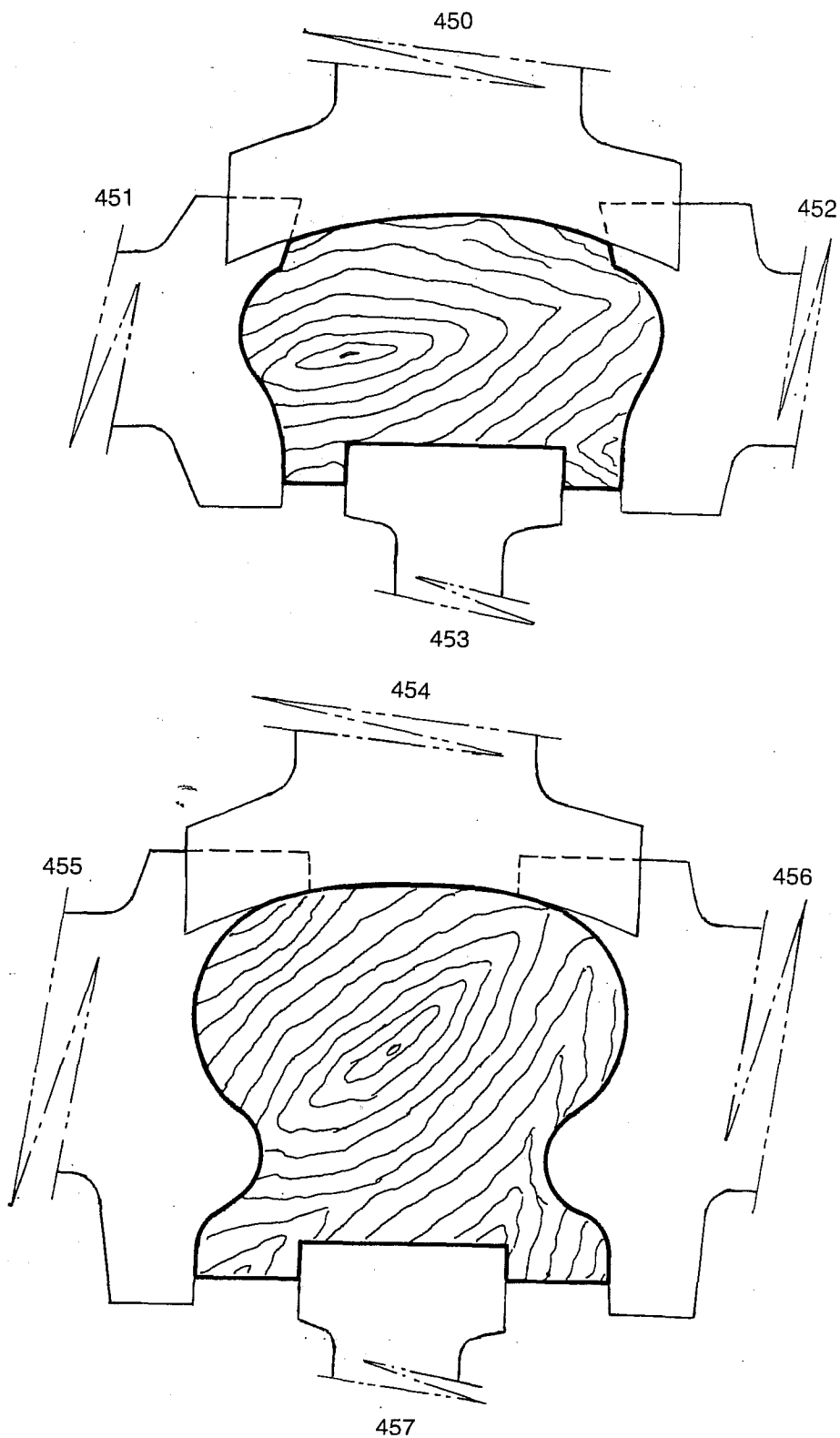

**4 cortes**

Perfil nº	450	451	452	453	454	455	456	457
Diámetro	140	140	140	140	140	140	140	140
Aquiere	50	50	50	50	50	50	50	50

HSS	<b>341,90</b>	<b>306,10</b>	<b>306,10</b>	<b>129,16</b>	<b>341,90</b>	<b>341,90</b>	<b>341,90</b>	<b>129,16 €</b>
MD	<b>426,50</b>	<b>331,30</b>	<b>331,30</b>	<b>133,90</b>	<b>426,50</b>	<b>426,50</b>	<b>426,50</b>	<b>133,90 €</b>

**165 PASAMANOS**

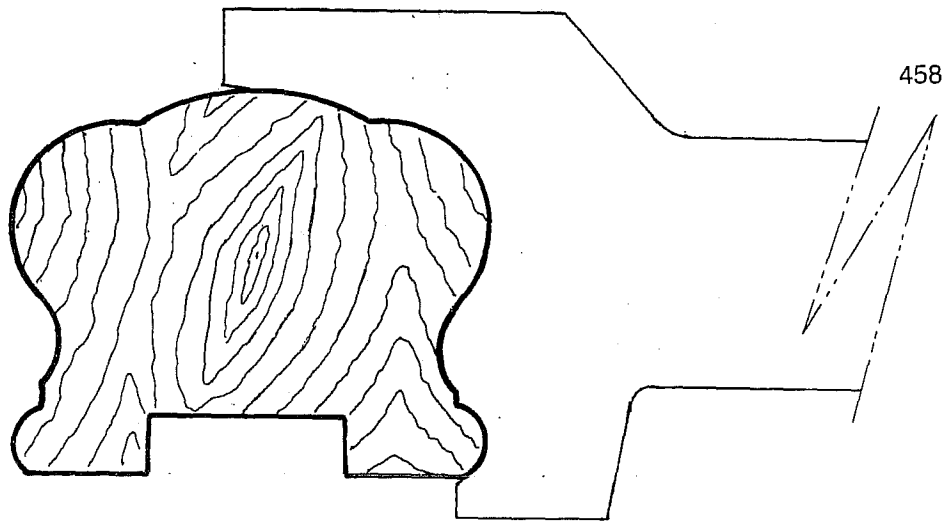

458

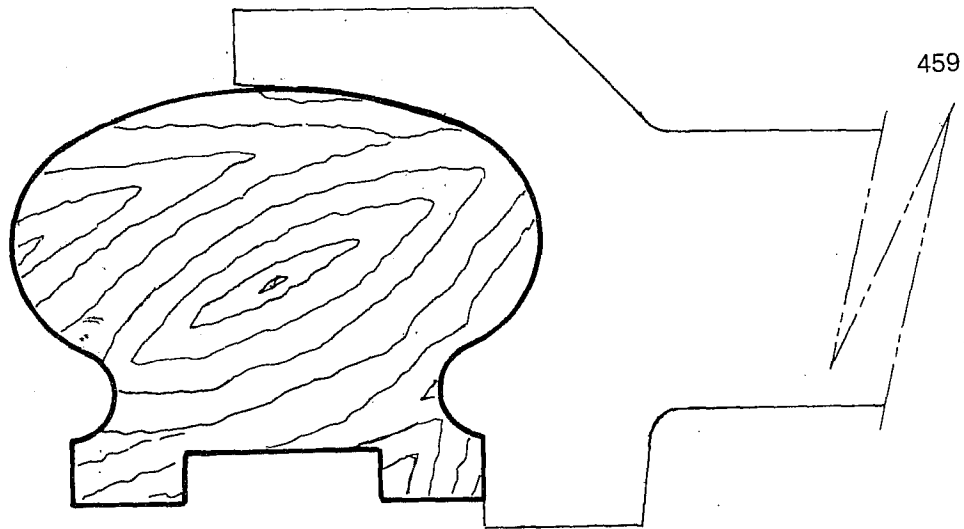

459

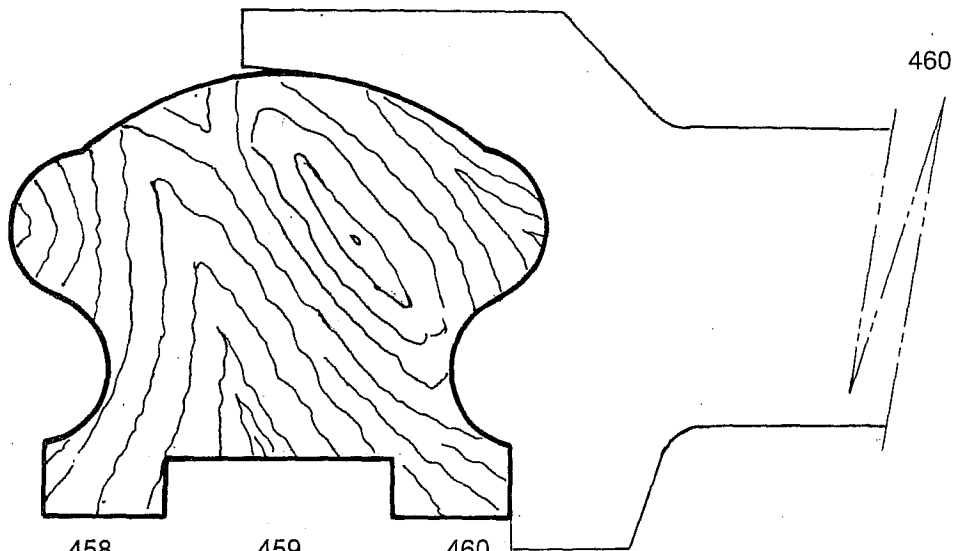

460

**4 cortes**

Perfil nº	458	459	460
Diámetro	190	200	190
Agujero	50	50	50
HSS	<b>401,00</b>	<b>401,00</b>	<b>401,00 €</b>
MD	<b>709,10</b>	<b>709,10</b>	<b>709,10 €</b>

**165 MOLDURAS**

470

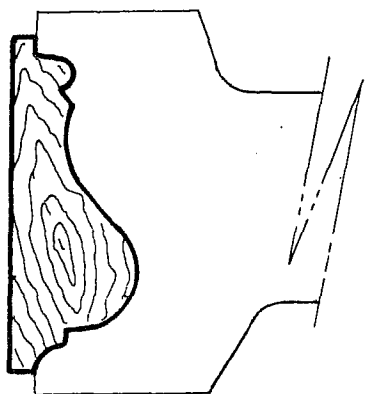

473

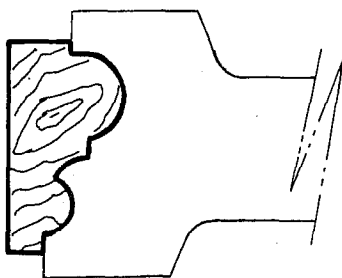

477

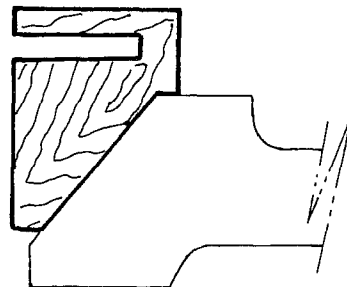

471

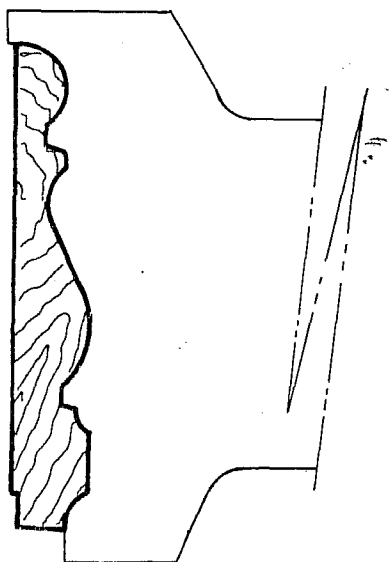

474

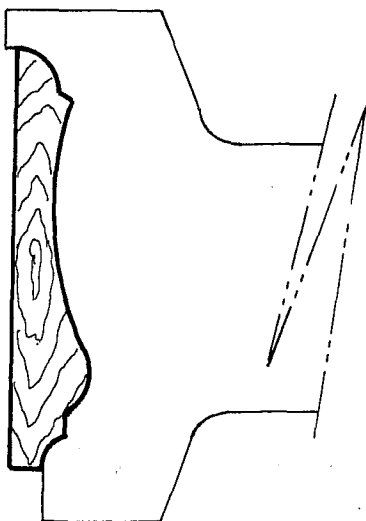

478

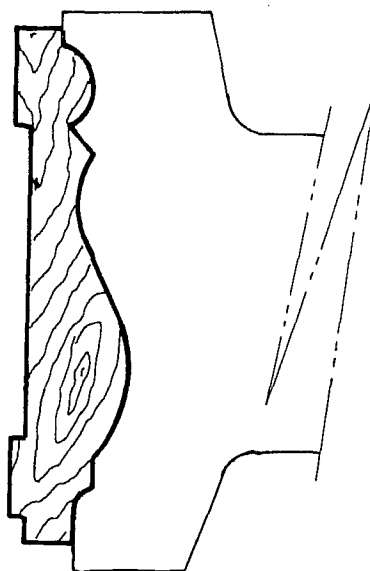

**4 cortes**

Perfil nº	470	471	473	474	477	478
Diámetro	140	140	140	140	140	140
Agujero	50	50	50	50	50	50

HSS	306,10	356,50	287,30	341,90	242,30	356,50 €
MD	331,30	451,80	296,60	426,50	278,50	451,80 €

**165 MOLDURAS**

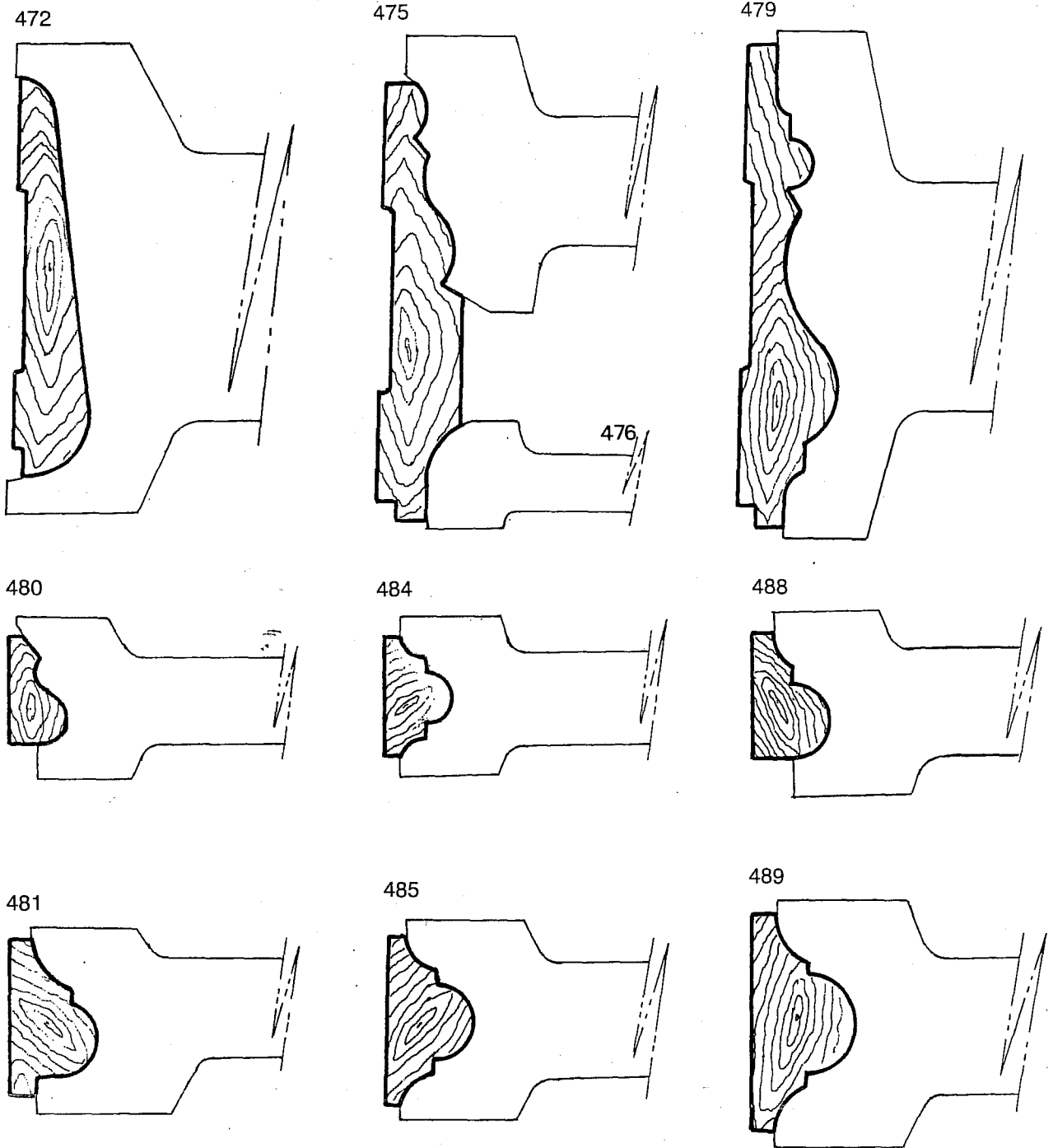

**4 cortes**

Perfil nº	472	475	476	479	480	481	484	485	488	489
Diámetro	140	140	132	140	140	140	140	140	140	140
Agujero	50	50	50	50	50	50	50	50	50	50

HSS	356,50	306,10	215,90	356,50	242,30	242,30	242,30	242,30	242,30	287,30€
MD	451,80	331,30	241,30	451,80	278,50	278,50	278,50	278,50	278,50	296,60€

**165 MOLDURAS**

482

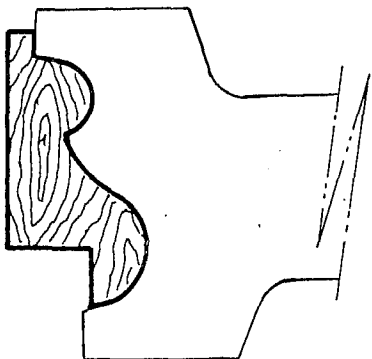

486

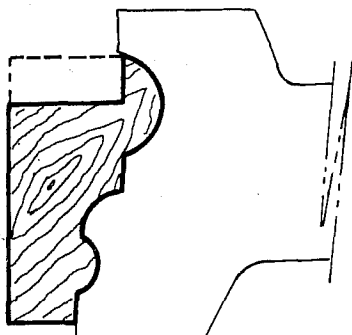

490

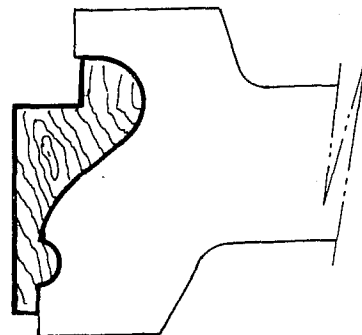

483

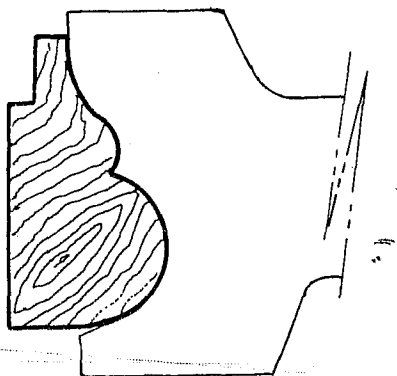

487

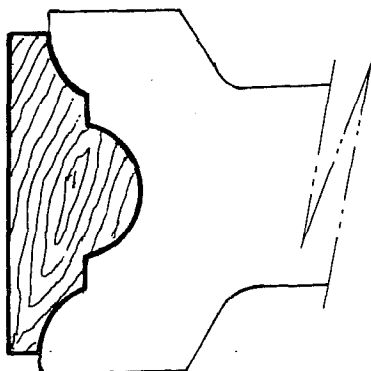

491

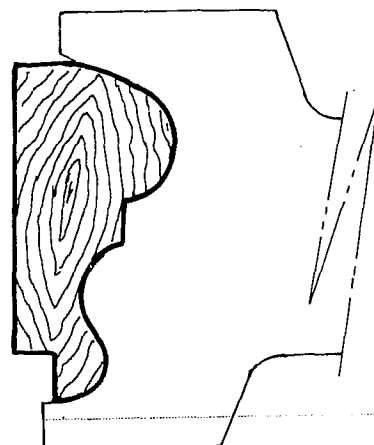

492

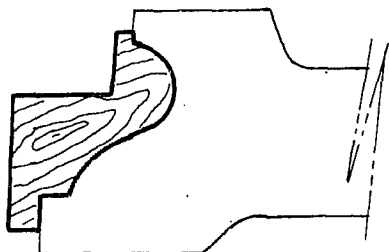

496

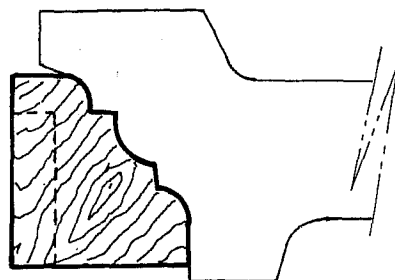

501

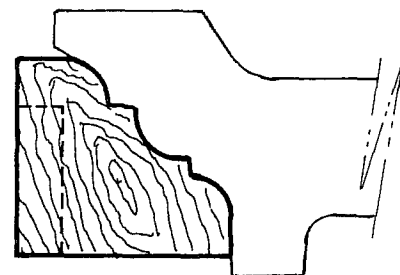

**4 cortes**

Perfil nº	482	483	486	487	490	491	492	496	501
Diámetro	140	140	140	140	140	150	150	150	160
Agujero	50	50	50	50	50	50	50	50	50
HSS	306,10	306,10	306,10	306,10	306,10	338,10	246,60	293,50	305,50 €
MD	331,30	331,30	331,30	331,30	331,30	406,50	288,00	305,50	367,70 €

**165 MOLDURAS**

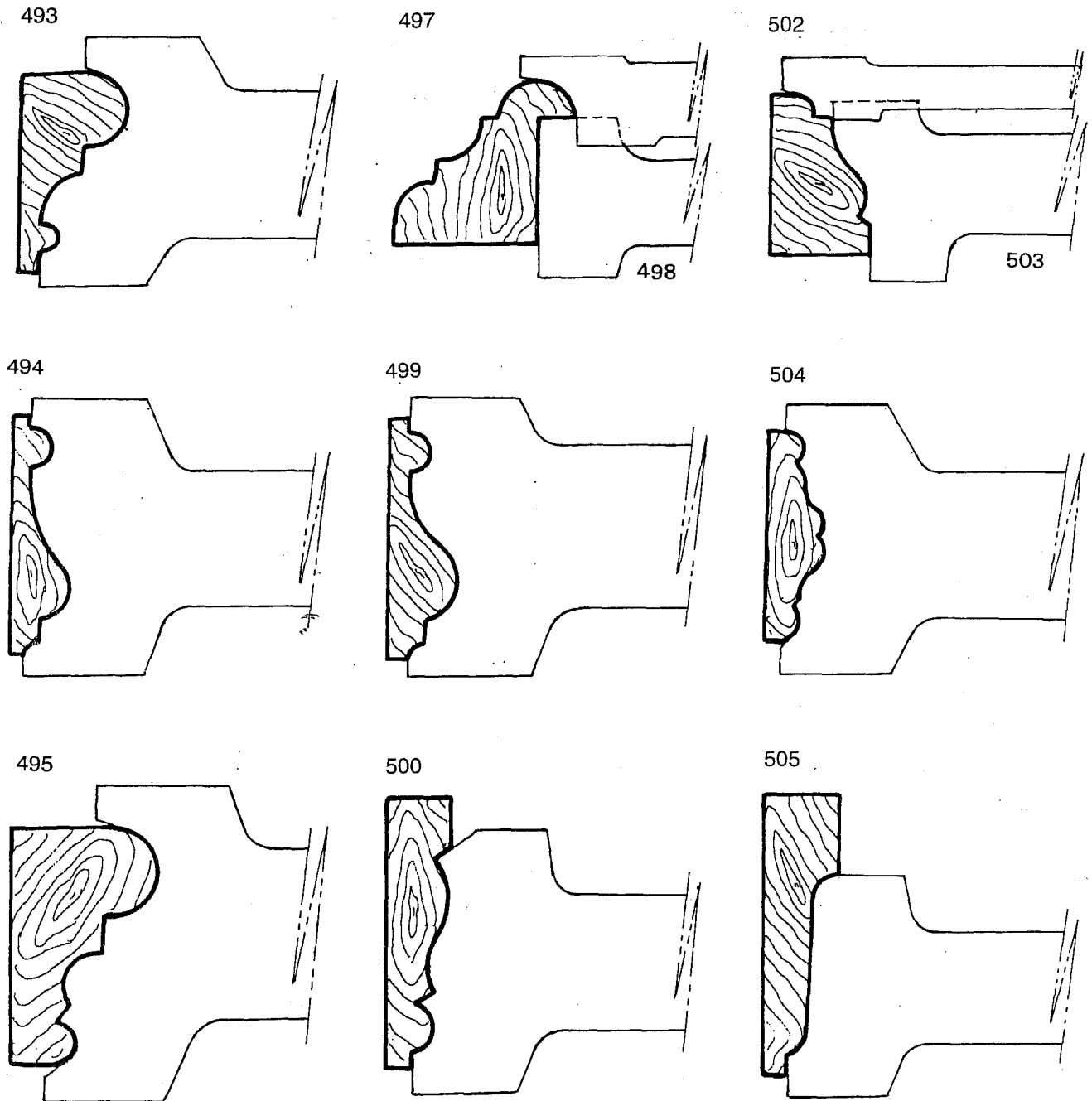

**4 cortes**

Perfil nº	493	494	495	497	498	499	500	502	503	504	505
Diámetro	140	140	150	140	134	140	140	150	134	140	140
Agujero 50	50	50	50	50	50	50	50	50	50	50	50
HSS	287,30	306,10	313,00	215,90	206,68	306,10	287,30	199,30	242,30	287,30	287,30 €
MD	299,60	331,30	339,45	241,30	217,56	331,30	296,60	209,30	278,50	296,60	296,60 €

**165 MOLDURAS**

507

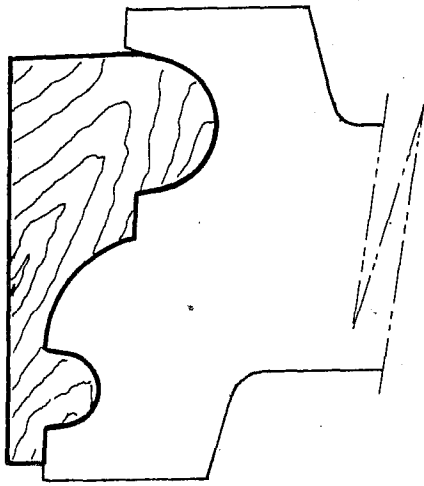

508



509

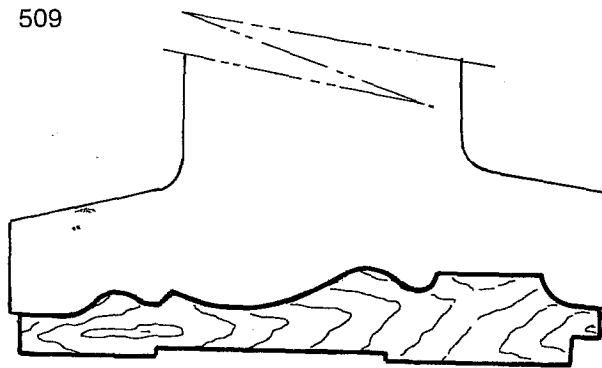

510

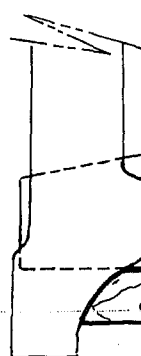

511

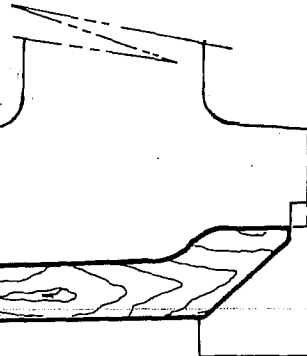

512

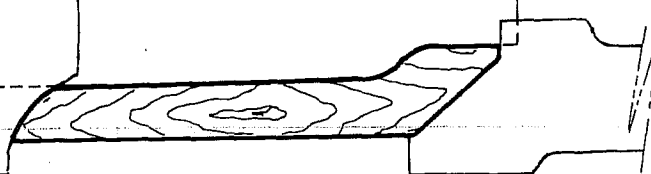

**4 cortes**

Perfil nº	507	508	509	510	511	512
Diámetro	160	140	140	140	140	140
Agujero	50	50	50	50	50	50

HSS	<b>347,90</b>	<b>306,10</b>	<b>356,50</b>	<b>215,90</b>	<b>356,50</b>	<b>215,90 €</b>
MD	<b>493,00</b>	<b>331,30</b>	<b>451,80</b>	<b>241,30</b>	<b>451,80</b>	<b>241,30 €</b>

**165 MOLDURAS**

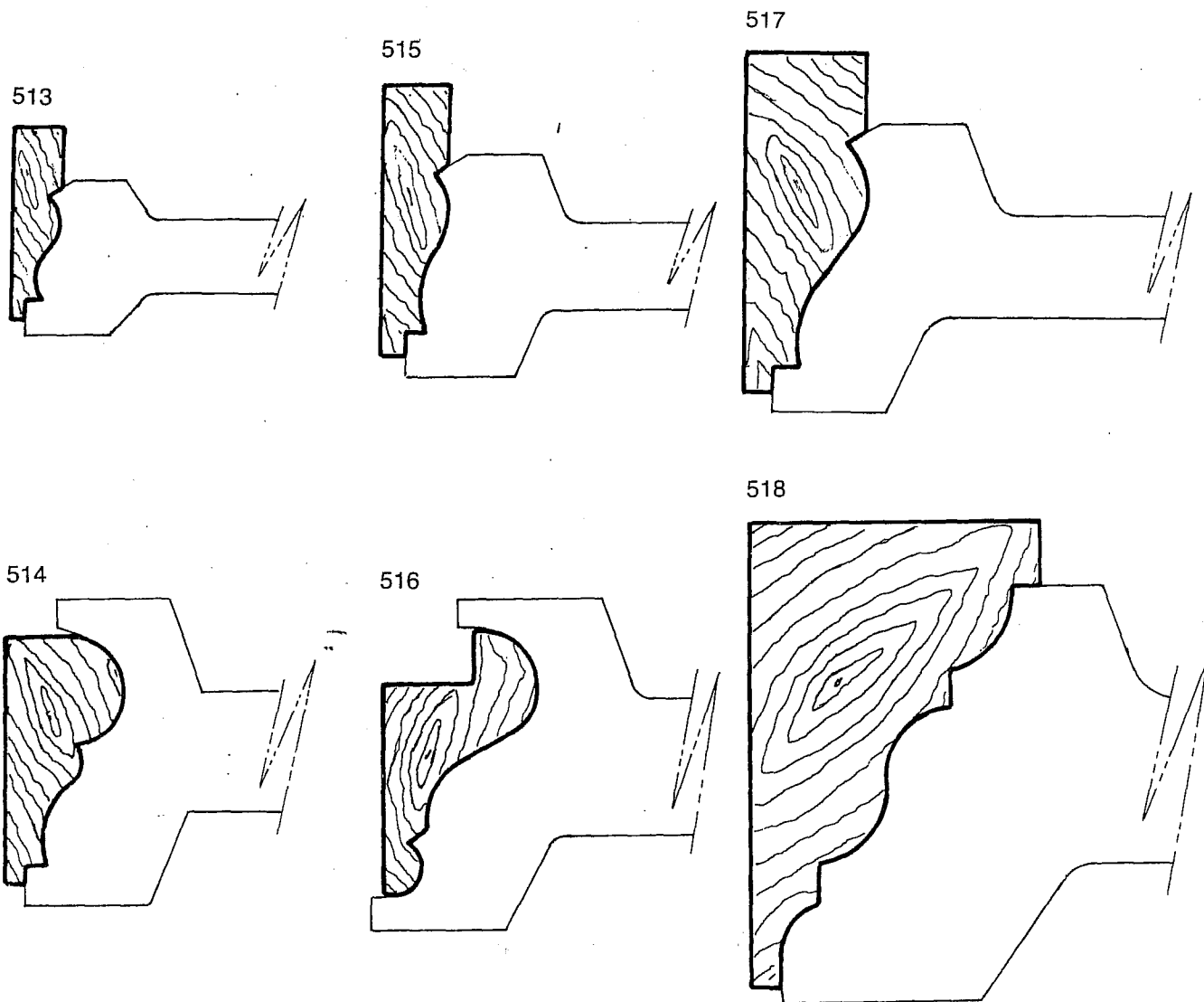

**4 cortes**

Perfil nº	513	514	515	516	517	518
Díámetro	140	140	140	160	140	180
Agujero	50	50	50	50	50	50
HSS	242,30	306,10	287,30	320,50	287,30	358,20 €
MD	278,50	331,30	296,60	427,60	296,60	574,20 €

165 MOLDURAS

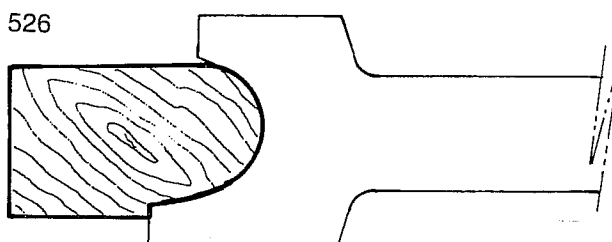
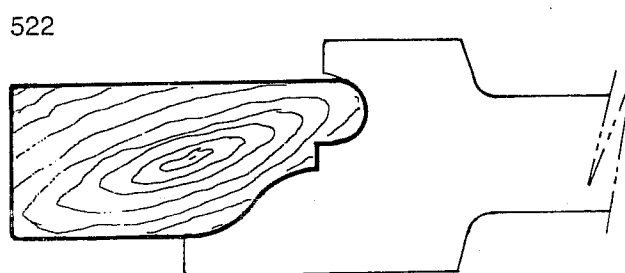
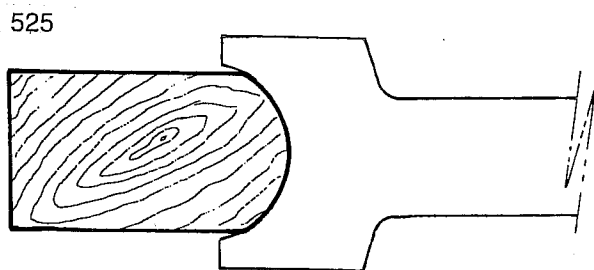
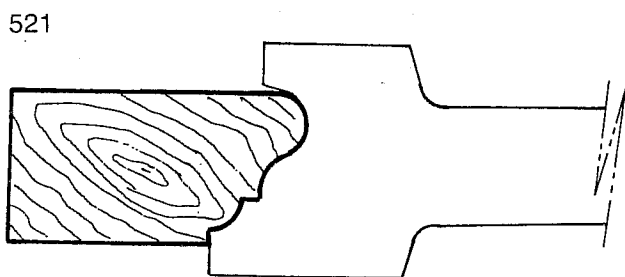
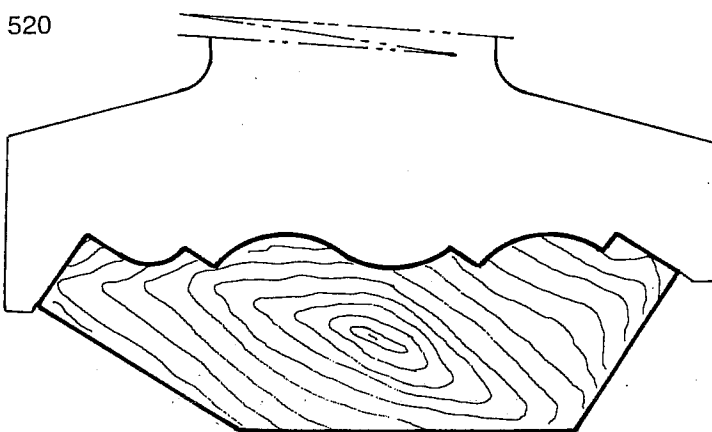
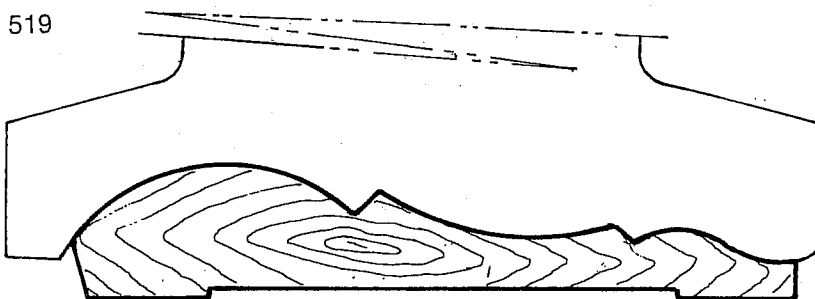

4 Cortes

Perfil nº	519	520	521	522	525	526
Diámetro	140	140	140	160	140	140
Agujero	50	50	50	50	50	50

HSS	412,70	393,10	242,30	279,80	242,30	242,30 €
MD	553,60	515,30	278,50	331,60	278,50	278,50 €

165 MOLDURAS

523

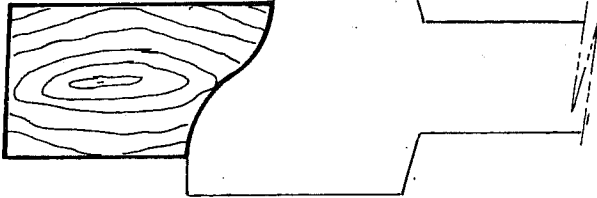

527

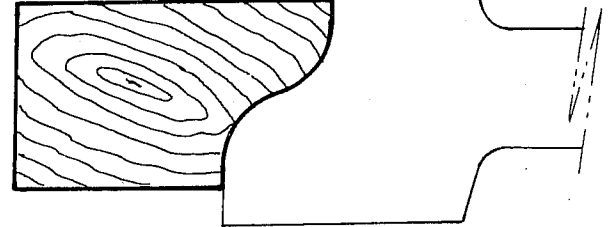

524

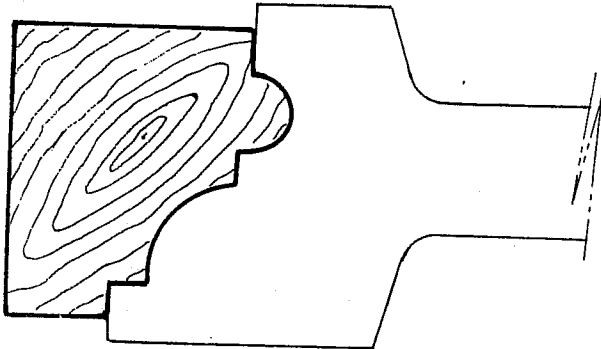

528

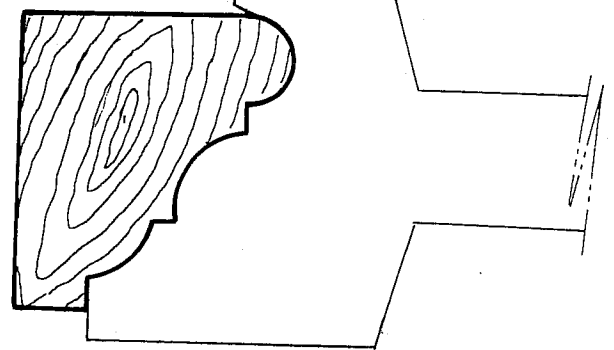

529

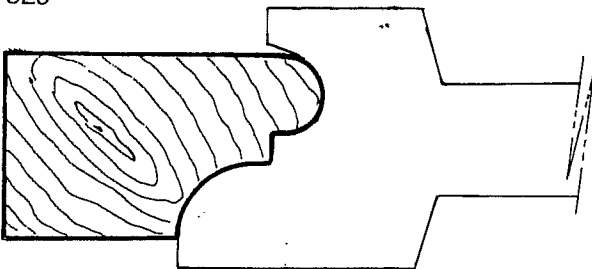

533

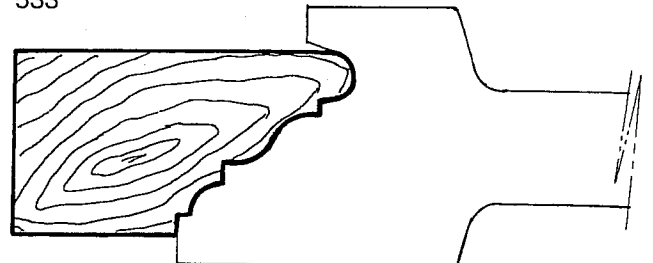

530

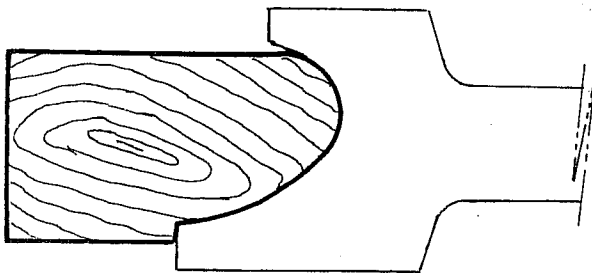

534

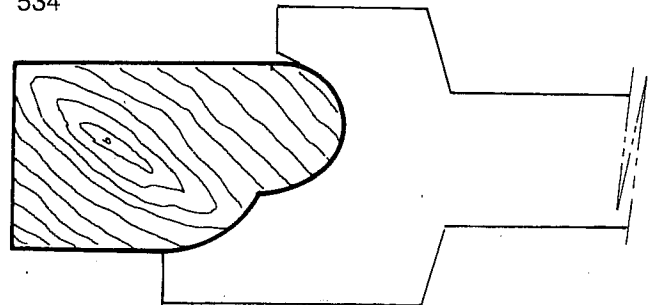

**4 cortes**

Perfil n°	523	524	527	528	529	530	533	534
Diámetro	140	160	140	160	150	150	160	160
Agujero	50	50	50	50	50	50	50	50

HSS	242,30	320,50	287,30	320,50	293,50	293,50	305,50	305,50 €
MD	278,50	427,60	296,60	427,60	305,50	305,50	367,70	367,70 €

**165 MOLDURAS**

531

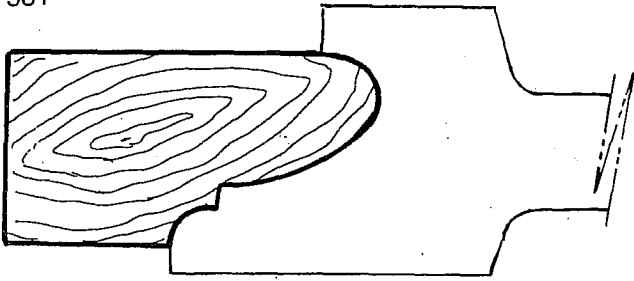

535

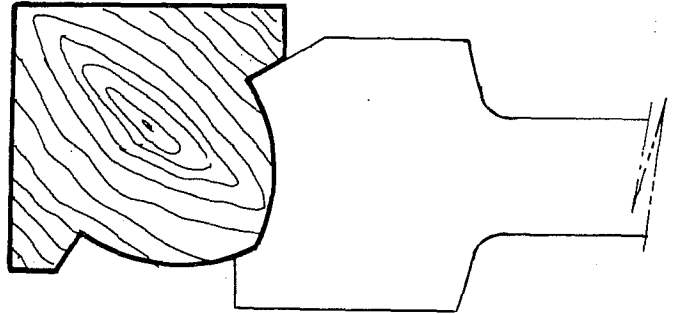

532

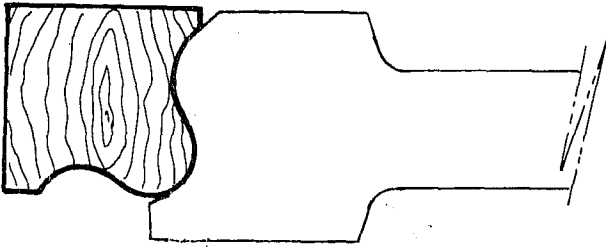

536

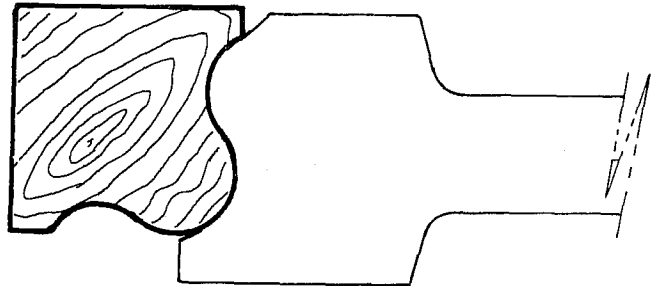

537

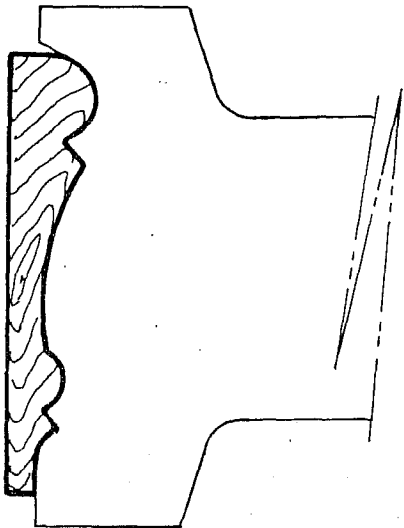

540

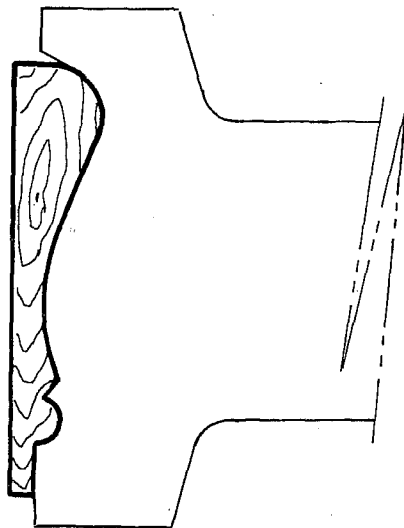

543

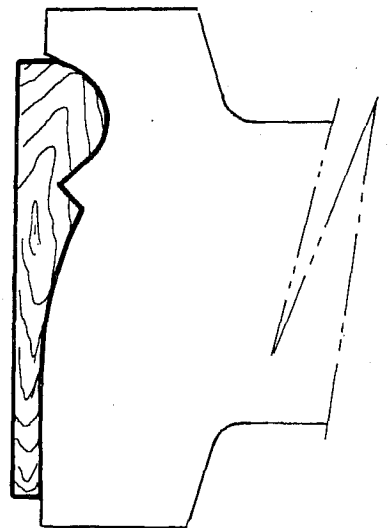

**4 cortes**

Perfil nº	531	532	535	536	537	540	543
Diámetro	160	140	140	140	140	140	140
Agujero	50	50	50	50	50	50	50

HSS	<b>305,50</b>	<b>242,30</b>	<b>287,30</b>	<b>287,30</b>	<b>341,90</b>	<b>341,90</b>	<b>341,90 €</b>
MD	<b>367,70</b>	<b>278,50</b>	<b>296,60</b>	<b>296,60</b>	<b>426,50</b>	<b>426,50</b>	<b>426,50 €</b>

**165 MOLDURAS**

538

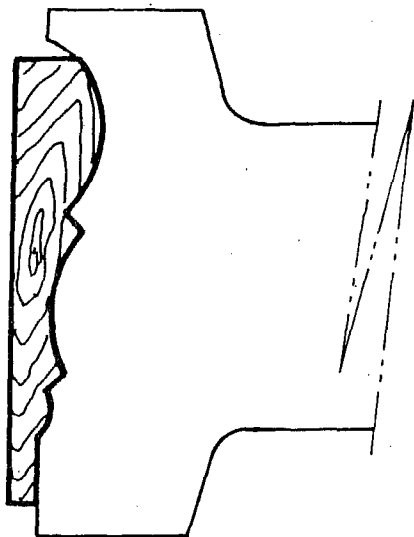

541

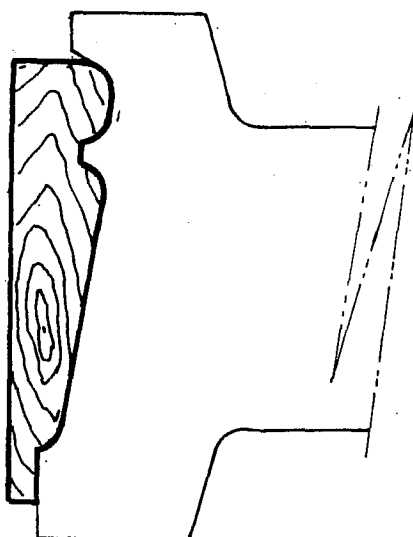

544

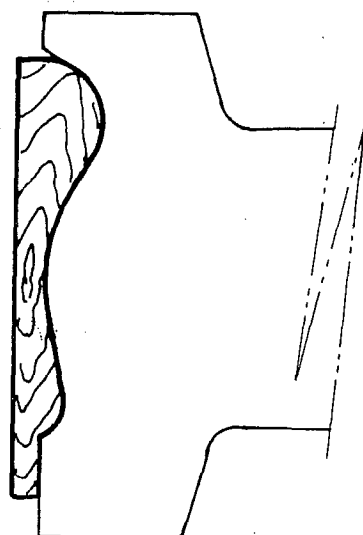

539

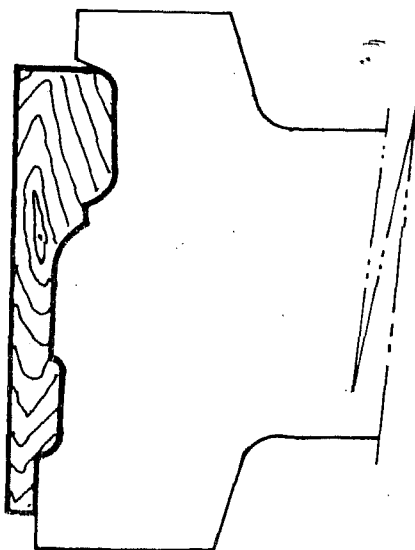

542

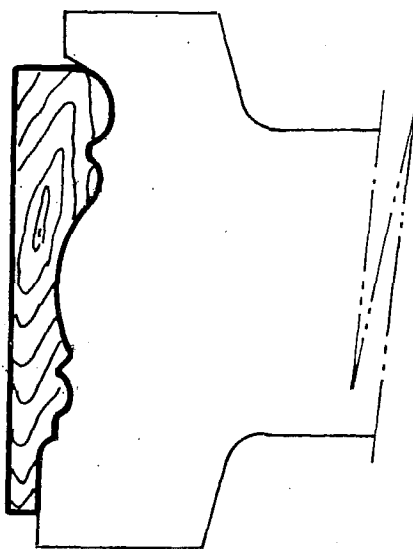

545



**4 cortes**

Perfil n°	538	539	541	542	544	545
Diámetro	140	140	140	140	140	140
Agujero	50	50	50	50	50	50

HSS	<b>341,90</b>	<b>341,90</b>	<b>341,90</b>	<b>341,90</b>	<b>341,90</b>	<b>341,90 €</b>
MD	<b>426,50</b>	<b>426,50</b>	<b>426,50</b>	<b>426,50</b>	<b>426,50</b>	<b>426,50 €</b>

**165 MOLDURAS**

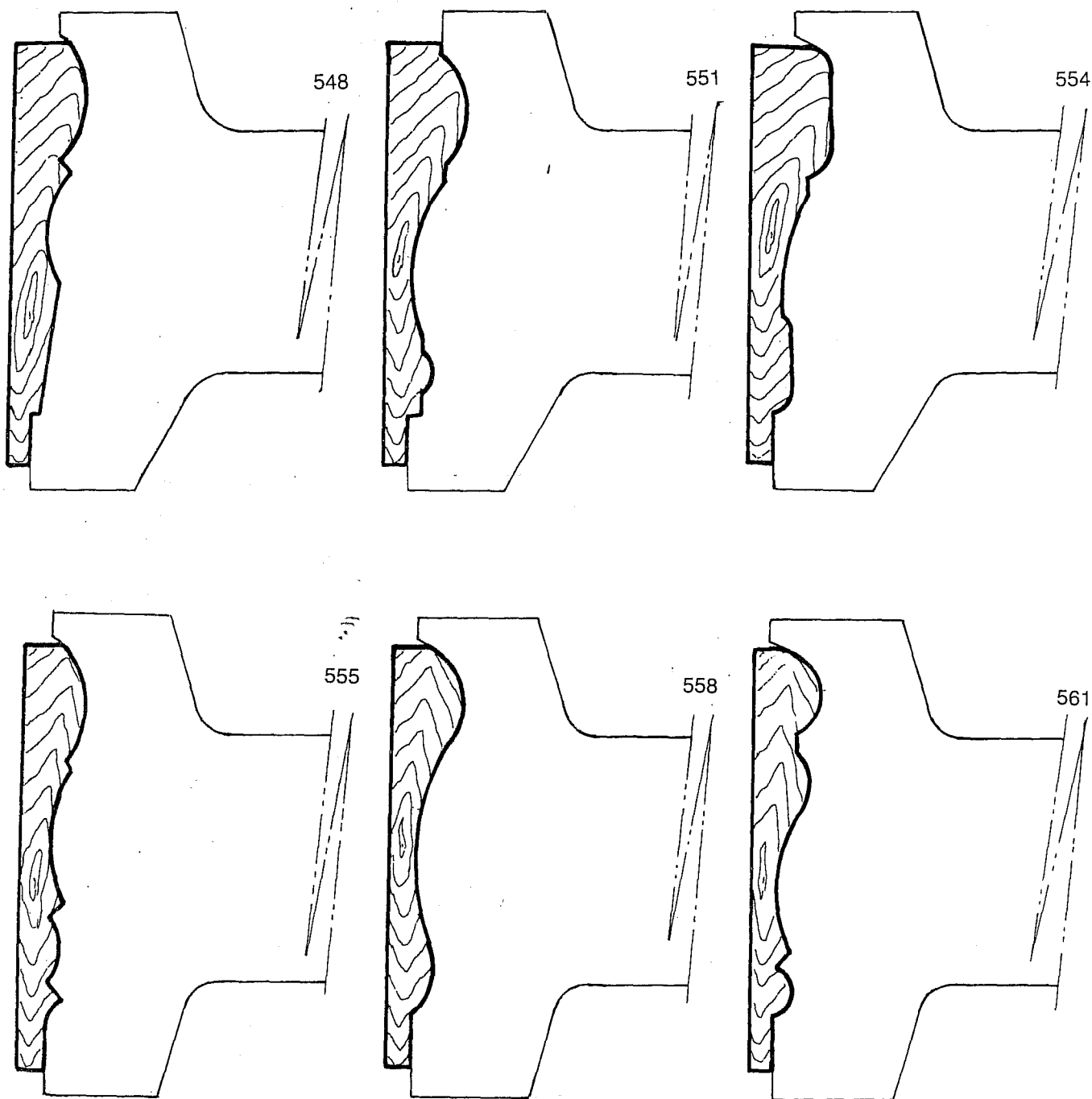

**4 cortes**

Perfil n.º	548	551	554	555	558	561
Diámetro	140	140	140	140	140	140
Agujero	50	50	50	50	50	50
HSS	<b>356,50</b>	<b>356,50</b>	<b>356,50</b>	<b>356,50</b>	<b>356,50</b>	<b>356,50 €</b>
MD	<b>451,80</b>	<b>451,80</b>	<b>451,80</b>	<b>451,80</b>	<b>451,80</b>	<b>451,80 €</b>

**165 MOLDURAS**

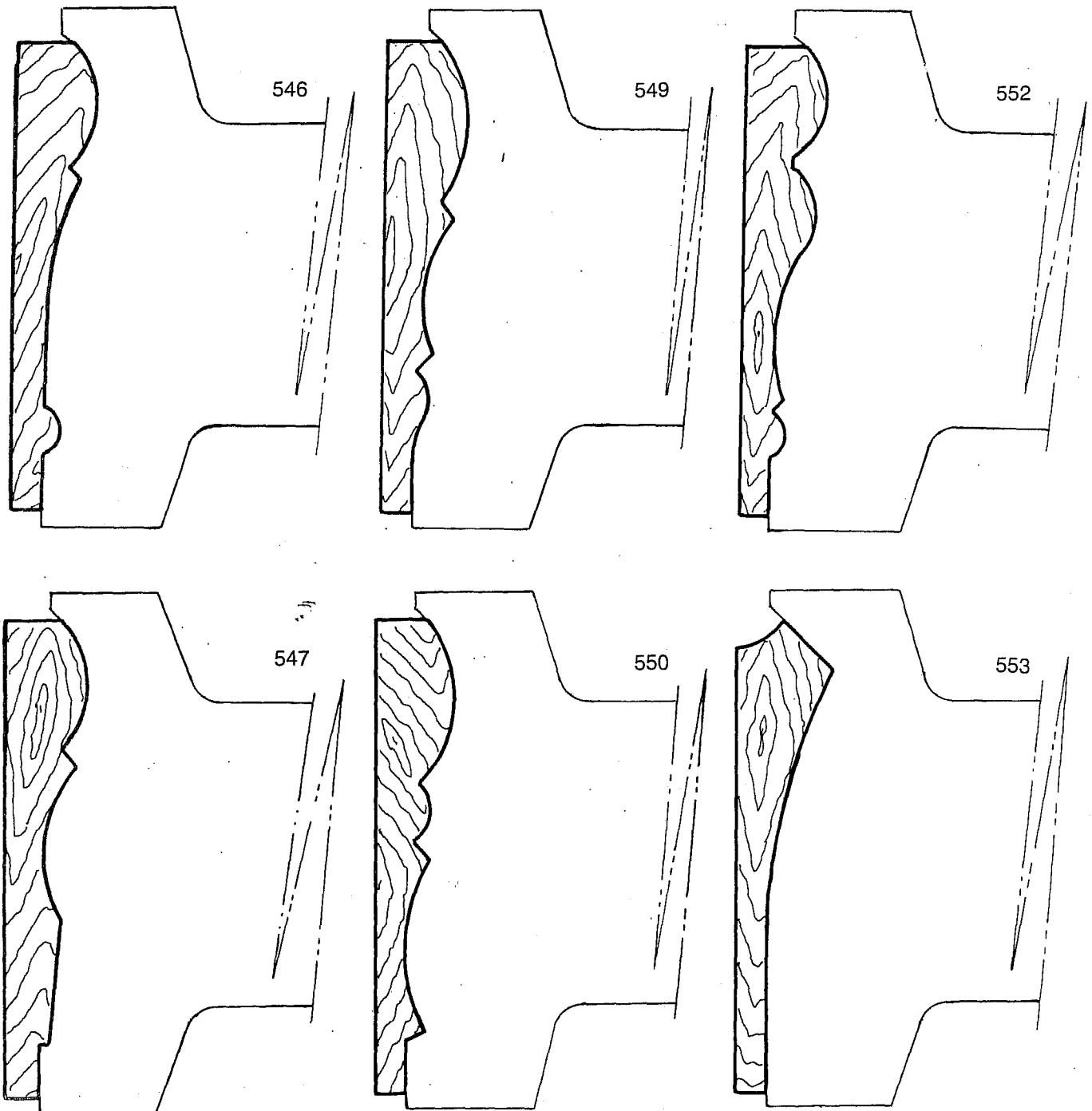

**4 cortes**

Perfil n°	546	547	549	550	552	553
Diámetro	140	140	140	140	140	140
Agujero	50	50	50	50	50	50

HSS	<b>373,50</b>	<b>373,50</b>	<b>373,50</b>	<b>373,50</b>	<b>373,50</b>	<b>373,50 €</b>
MD	<b>477,00</b>	<b>477,00</b>	<b>477,00</b>	<b>477,00</b>	<b>477,00</b>	<b>477,00 €</b>

**165 MOLDURAS**

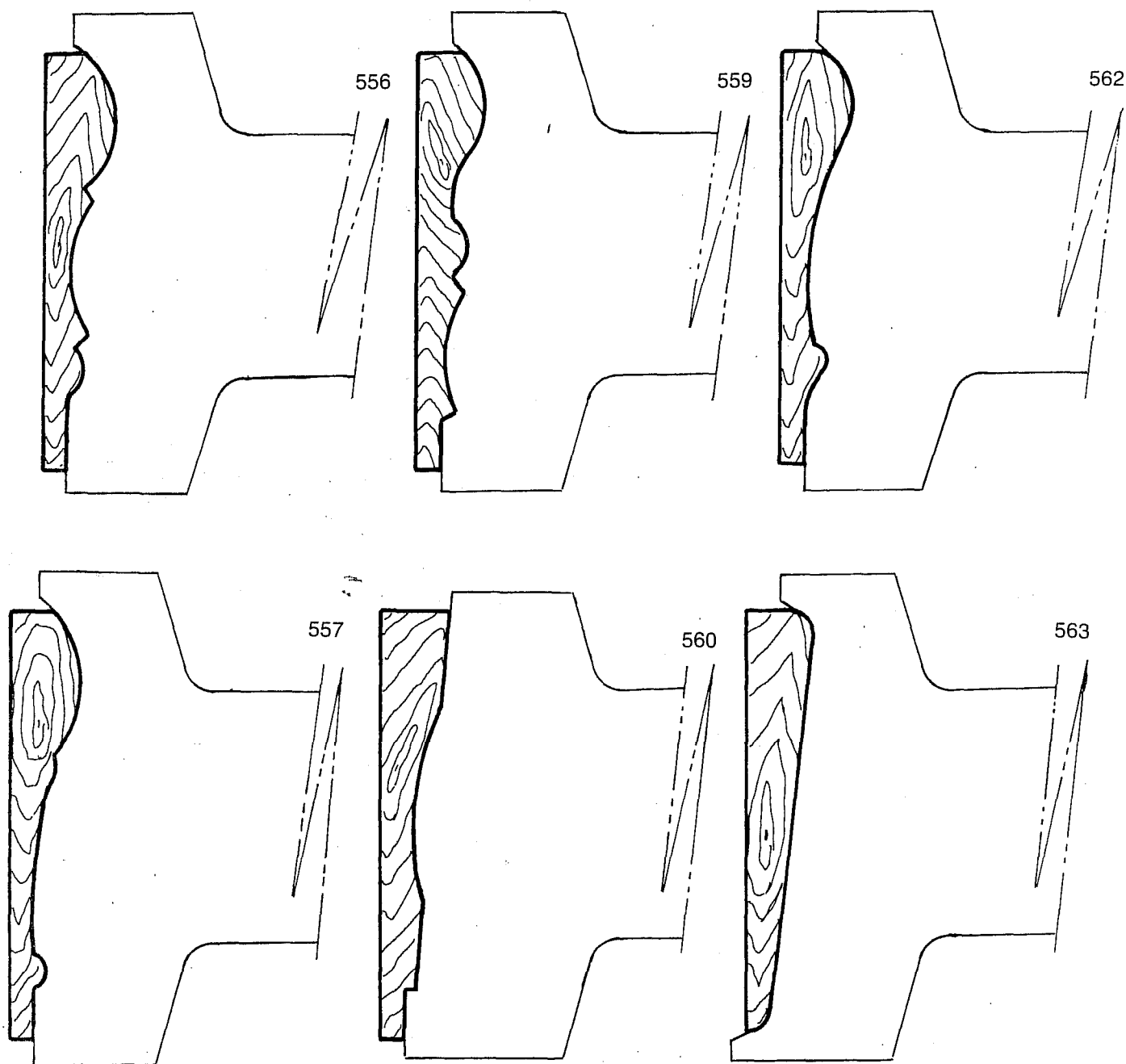

**4 cortes**

Perfil nº	556	557	559	560	562	563
Diámetro	140	140	140	140	140	140
Agujero	50	50	50	50	50	50
HSS	<b>356,50</b>	<b>356,50</b>	<b>356,50</b>	<b>356,50</b>	<b>356,50</b>	<b>356,50 €</b>
MD	<b>451,80</b>	<b>451,80</b>	<b>451,80</b>	<b>451,80</b>	<b>451,80</b>	<b>451,80 €</b>

**165 MOLDURAS DE MUEBLES**

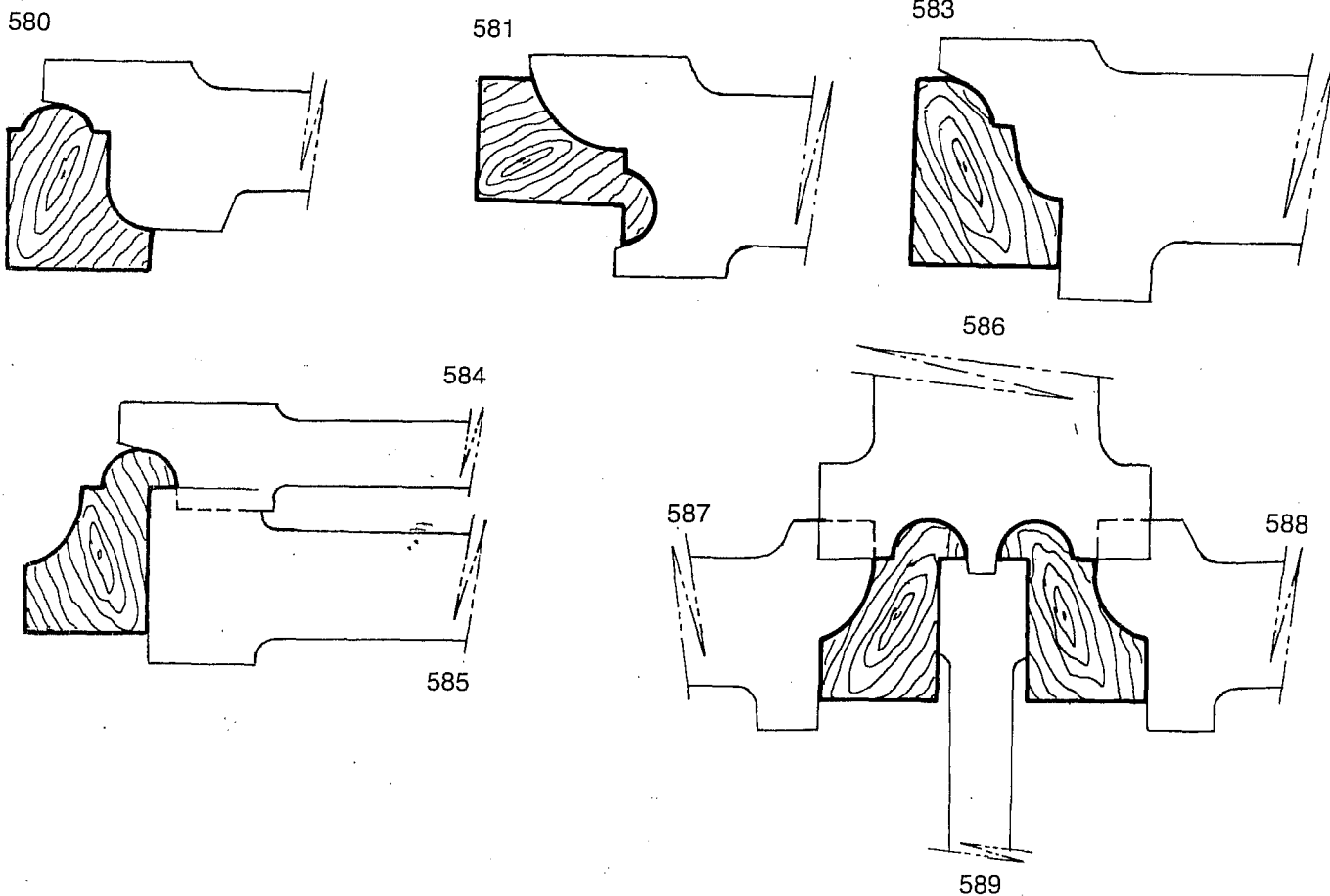

**4 cortes**

Perfil nº	580	581	583	584	585	586	587	588	589
Diámetro	140	150	140	148	140	140	140	140	140
Aquero	50	50	50	50	50	50	50	50	50

HSS	<b>242,30</b>	<b>246,60</b>	<b>287,30</b>	<b>221,90</b>	<b>159,30</b>	<b>306,10</b>	<b>242,30</b>	<b>242,30</b>	<b>108,55 €</b>
MD	<b>278,50</b>	<b>288,00</b>	<b>296,60</b>	<b>245,40</b>	<b>164,10</b>	<b>331,30</b>	<b>278,50</b>	<b>278,50</b>	<b>109,30 €</b>

**165 MOLDURAS DE MUEBLES**

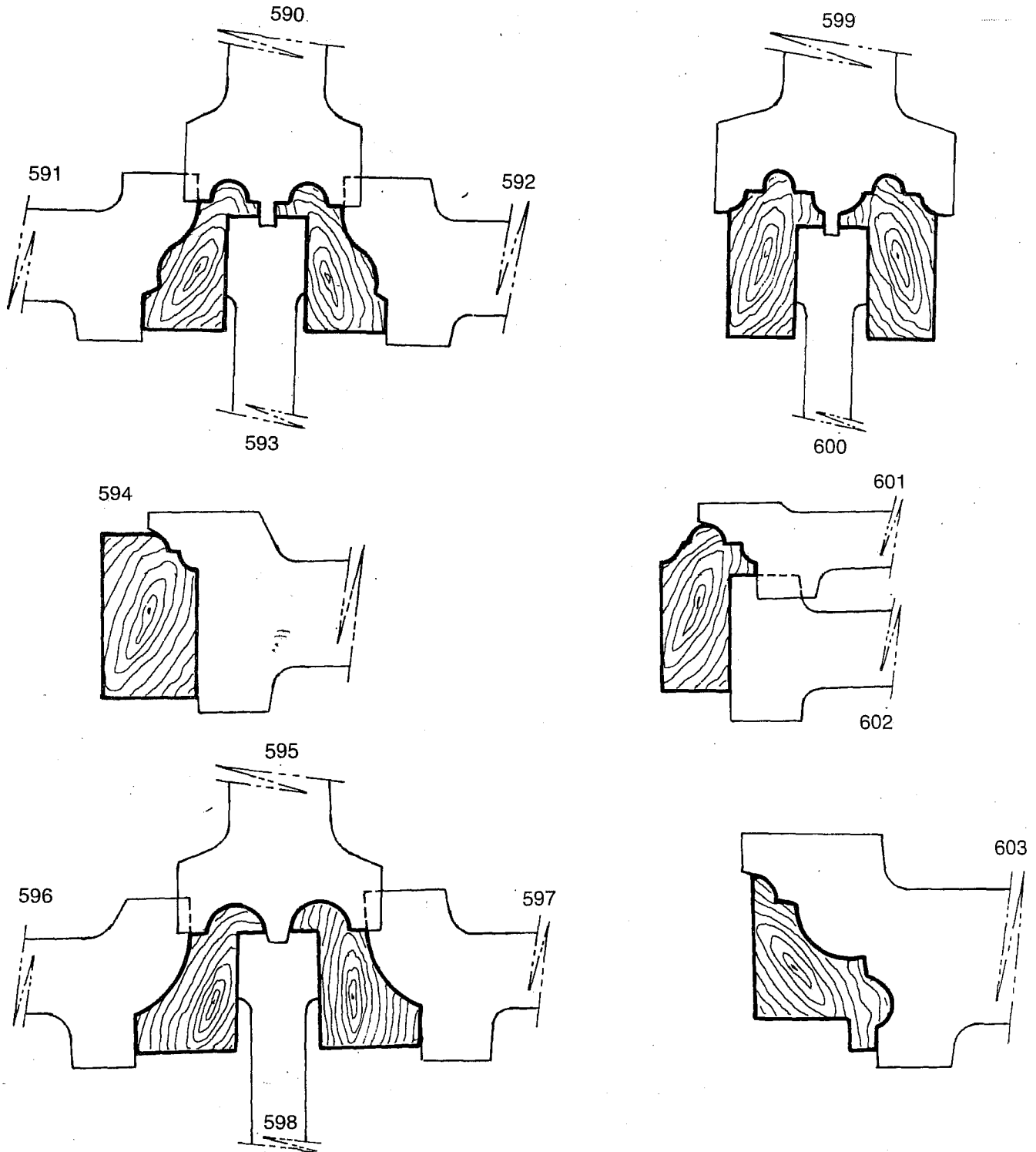

	590	591	592	593	594	595	596	597	598	599	600	601	602	603
<b>4 cortes</b>														
Perfil nº														
Diámetro			140	140	140	140	140	140	140		140	150	140	160
Agujero			50	50	50	50	50	50	50		50	50	50	50
<b>HSS</b>	<b>242,30</b>	<b>125,50</b>	<b>287,30</b>	<b>287,30</b>	<b>242,30</b>	<b>125,50</b>	<b>221,90</b>	<b>159,30</b>	<b>305,50 €</b>					
<b>MD</b>	<b>278,50</b>	<b>131,00</b>	<b>296,60</b>	<b>296,60</b>	<b>278,50</b>	<b>131,00</b>	<b>245,40</b>	<b>164,10</b>	<b>367,70 €</b>					

**170 FRESA PARA REBAJAR PLAFONES**

**4 CORTES**

**MEC- ALIMENTACION MECANICA**

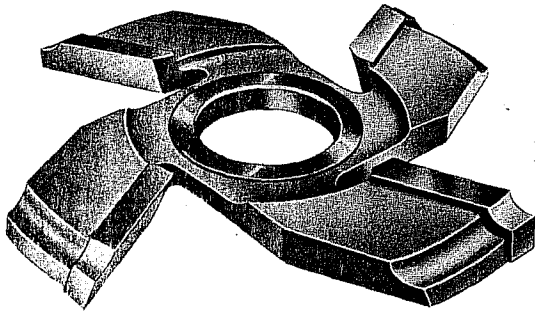

Se suministra con los perfiles normalizados o especiales de las páginas siguientes.  
Según dibujo o muestra de madera fabricamos cualquier perfil.

	<b>HSS</b>	<b>MD</b>
<b>Perfiles normales 215 a 224</b>		
D.210 50 eje.		
Posición superior (normal)	<b>242,00</b>	<b>355,00 €</b>
Posición inferior (especial)	<b>259,50</b>	<b>359,50 €</b>
<b>Perfiles especiales</b>		
D.180 y 210 mm.		
Ancho de corte hasta 20 mm.	<b>259,50</b>	<b>359,50 €</b>

**171 FRESA PARA REBAJAR PLAFONES**

**3+3 CORTES**

**MEC- ALIMENTACION MECANICA**

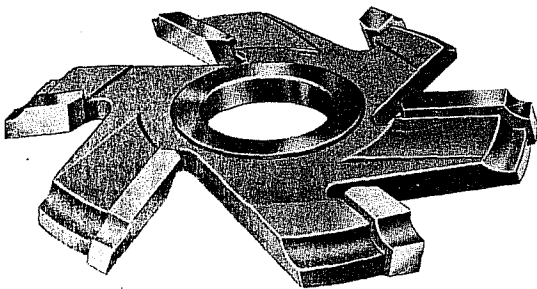

Se suministra con los perfiles normalizados o especiales de las páginas siguientes.  
Según dibujo o muestra de madera fabricamos cualquier perfil.

	<b>HSS</b>	<b>MD</b>
<b>Cualquier perfil</b>		
D. 180 y 210 mm.		
Ancho de corte hasta 20 mm.	<b>316,10</b>	<b>438,10 €</b>

### PERFILES NORMALES DE FRESAS PARA REBAJAR PLAFONES

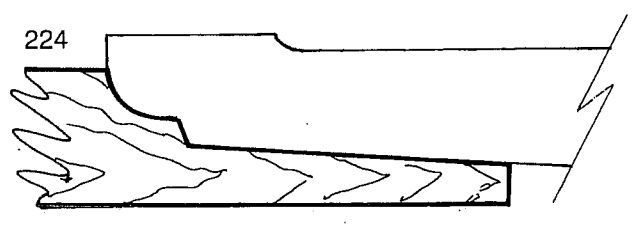
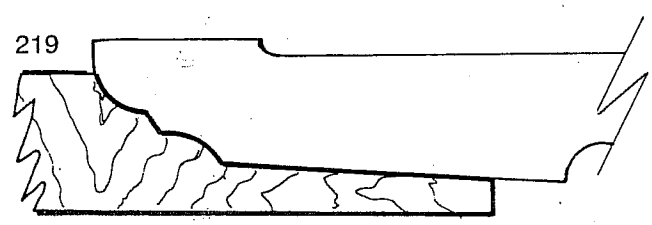
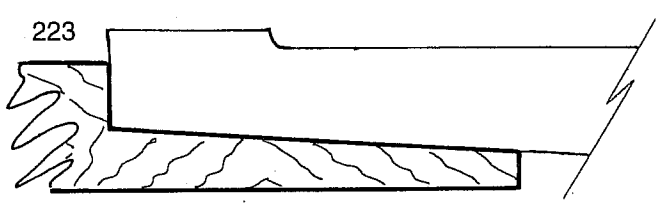
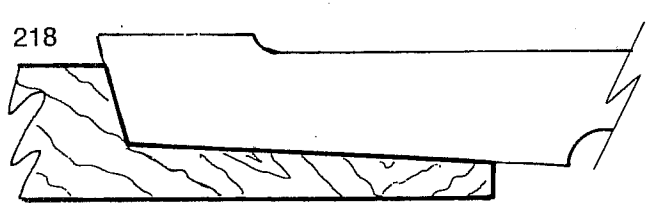
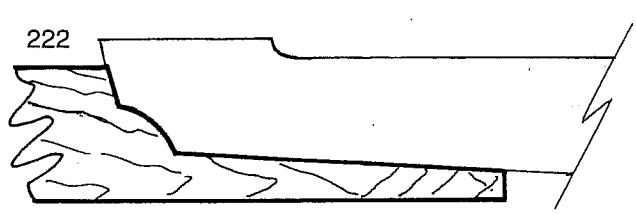
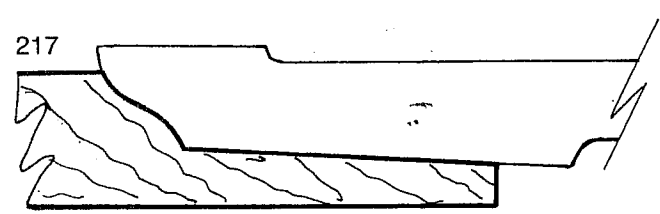
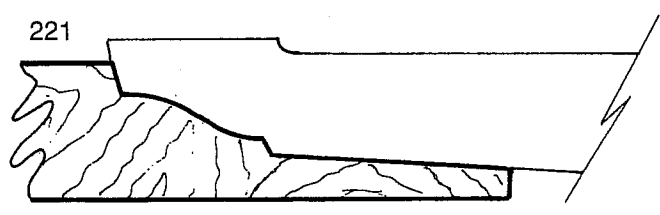
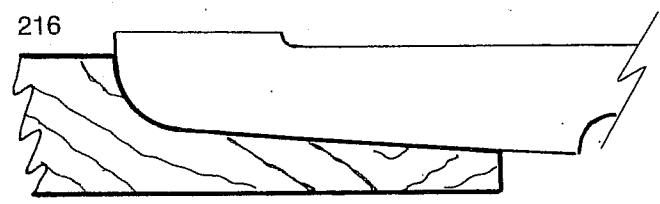
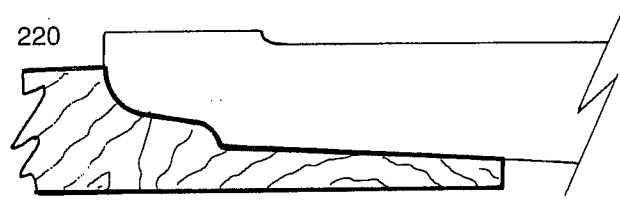
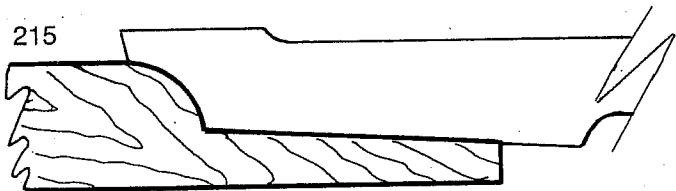

**PERFILES ESPECIALES DE FRESAS PARA REBAJAR PLAFONES**

231

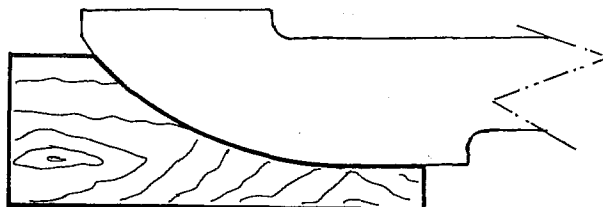

235



232

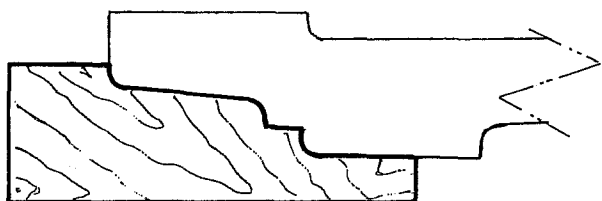

236

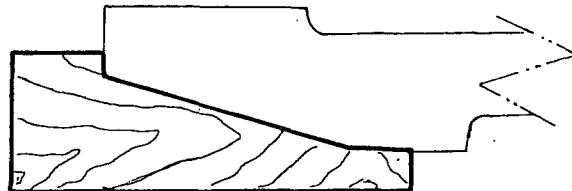

233

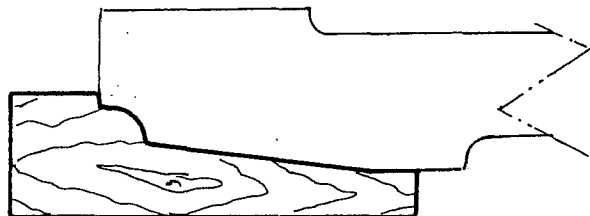

237

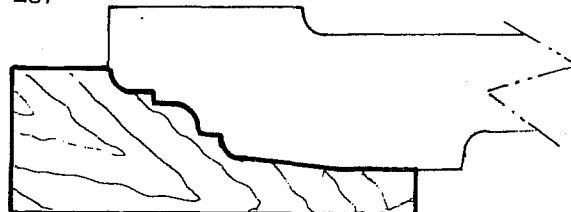

234

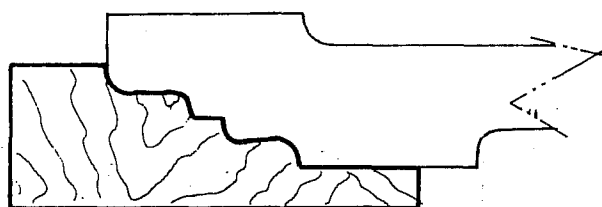

238

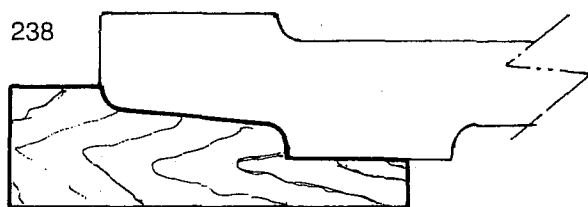

**4 cortes**

Perfiles especiales 231 al 238  
D.180 y 210 mm.

**HSS**

**259,50**

**MD**

**359,50 €**

**PERFILES ESPECIALES DE FRESAS DE REBAJAR PLAFONES**

239

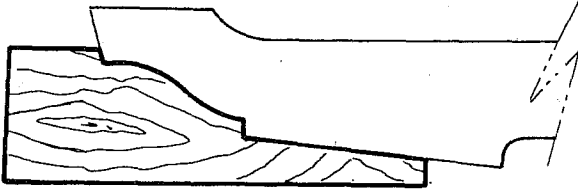

243

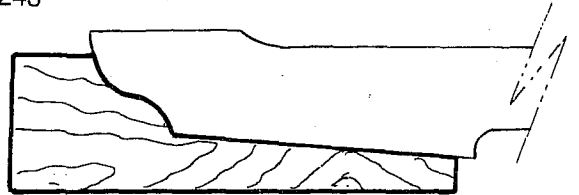

240



244



241

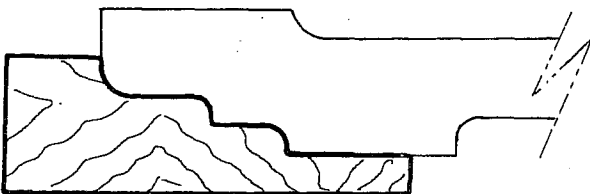

245



242

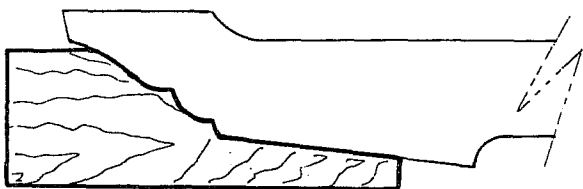

**4 cortes**

HSS MD

Perfiles especiales 239 a 245

D.180 y 210 mm.

**259,50 359,50 €**

MEC- ALIMENTACION MECANICA

Juego 4 fresas que permiten, en una o varias operaciones obtener una amplia gama perfiles.

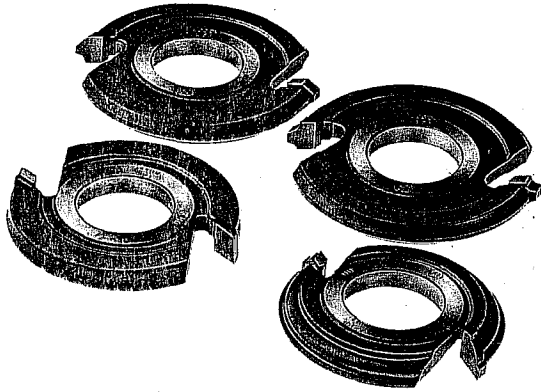

175/1 D.120 30 eje  
D.140 50 eje

175/2 D.100 30 eje  
D.120 50 eje

175/3 D.120 30 eje  
D.140 50 eje

175/4 D.107 30 eje  
D.127 50 eje

Juego 4 fresas 30 eje HSS 446,90 €  
MD 596,87 €

Juego 4 fresas 50 eje HSS 449,00 €  
MD 598,00 €

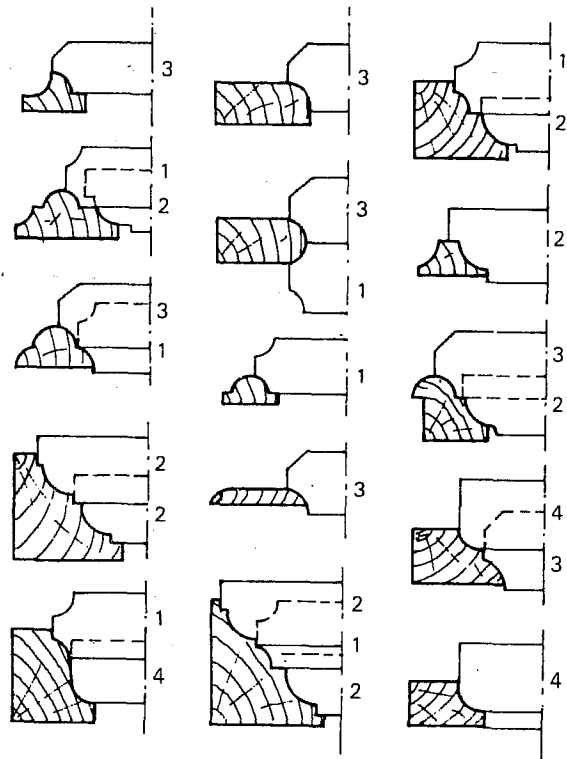
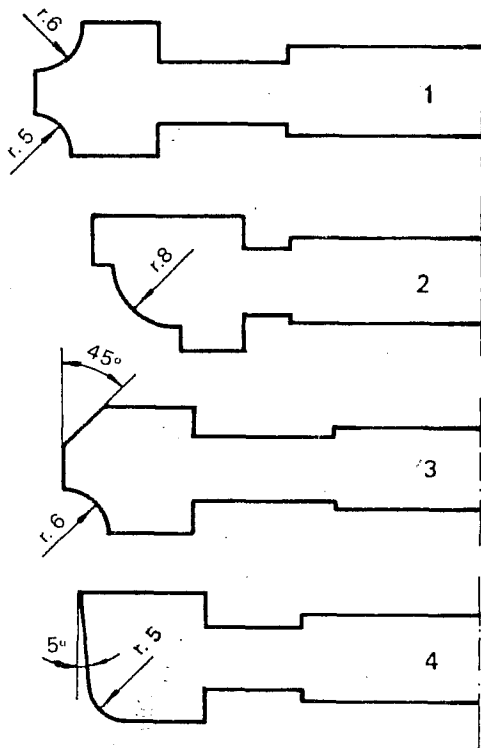

MEC- ALIMENTACION MECANICA

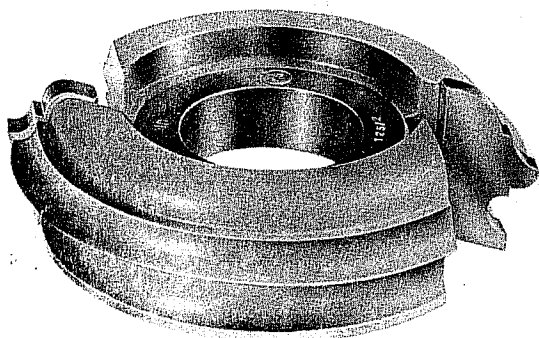

Fresa con la que pueden obtenerse muchos perfiles, en una o varias operaciones.

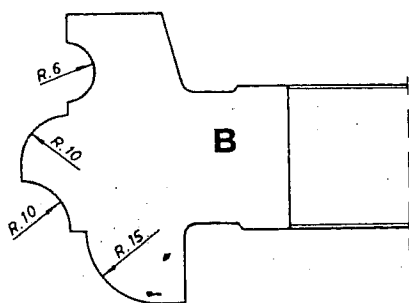
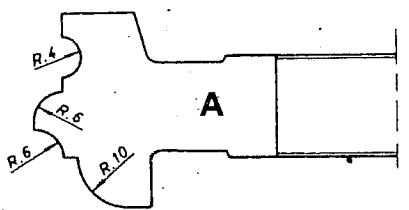

177/A	D.140 30 eje	HSS	166,40 €
		MD	202,10 €
	D.150 50 eje	HSS	169,40 €
		MD	206,90 €
177/B	D.150 30 eje	HSS	226,30 €
		MD	286,90 €
	D.160 50 eje	HSS	229,40 €
		MD	289,50 €

MEC- ALIMENTACION MECANICA

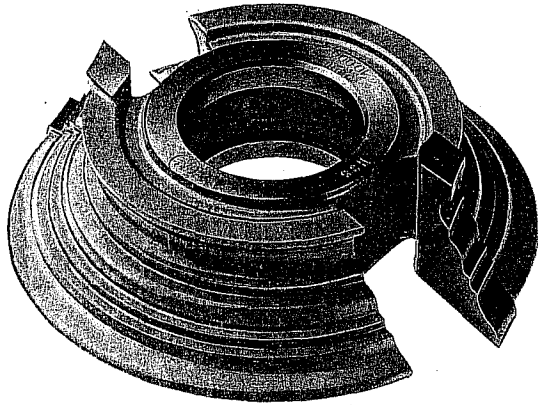

Herramienta que permite obtener una gran variedad de perfiles.

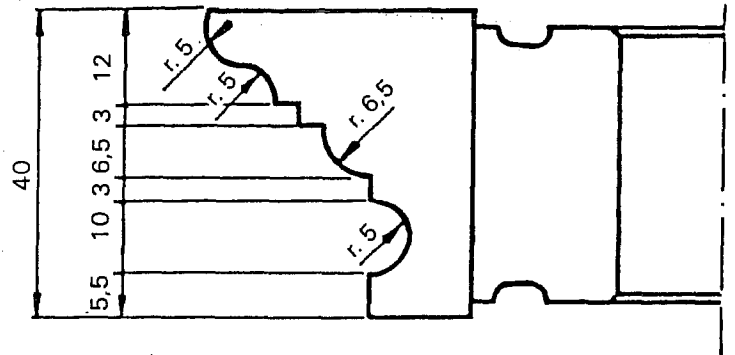

D.140 30 eje	HSS	202,70 €
	MD	244,00 €
D.160 50 eje	HSS	209,80 €
	MD	256,20 €

**180 JUEGO DE FRESAS PARA RADIOS 2 CORTES**

**MEC- ALIMENTACION MECANICA**

Juego de 3 fresas para trabajos de redondeado de cantos, molduras, palos redondos, etc.

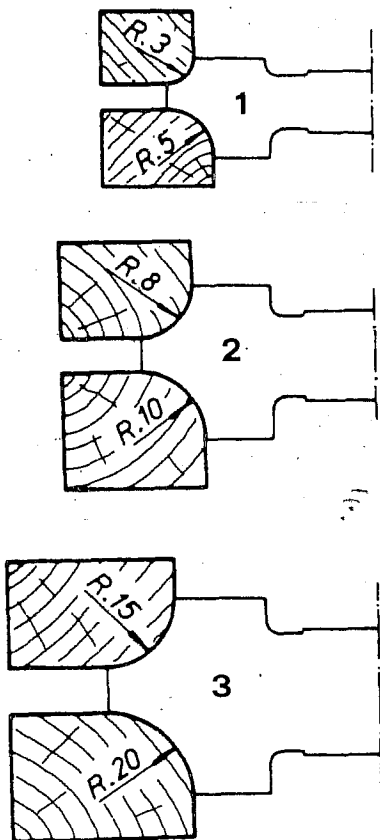

180/1	R-3/5	D.140	50 eje	HSS	127,00 €
				MD	141,00 €
180/2	R-8/10	D.140	50 eje	HSS	145,00 €
				MD	170,50 €
180/3	R-15/20	D.150	50 eje	HSS	189,00 €
				MD	227,25 €
Juego 3 fresas 50 eje				HSS	438,50 €
				MD	505,30 €

**182 FRESA PARA INGLETE 90°**

**MEC- ALIMENTACION MECANICA**

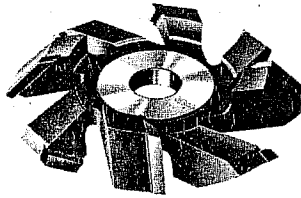

D.160x35x30 eje Z-3+3	MD	282,70 €
D.160x45x30 eje Z-3+3	MD	331,00 €
D.180x35x30 eje Z-4+4	MD	350,50 €
D.180x45x30 eje Z-4+4	MD	396,60 €
D.200x35x30 eje Z-4+4	MD	355,90 €
D.200x45x30 eje Z-4+4	MD	403,40 €

**185 FRESA PARA PALOS REDONDOS**

**4 CORTES**

**MEC- ALIMENTACION MECANICA**

Herramienta para trabajar en moldurera, trabajando una fresa por arriba y otra por debajo.

Valores de las aristas A y B

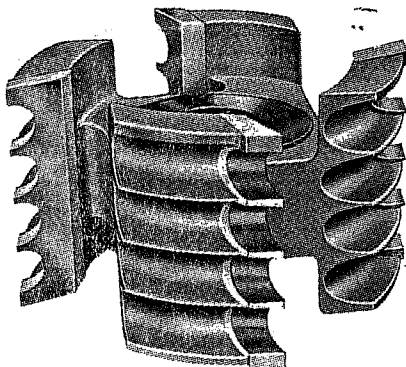

Dia. Palo	3 a 10	11 a 19	20 a 30 mm.
Arista lateral A	4	5	7 mm.
Arista central B	1	1,5	2 mm.

Ancho de corte		20	30	40	50	60	70	80
D.120 mm.	HSS	232,80	261,80	310,65	327,55	348,00	363,75	381,00 €
	MD	259,60	299,20	310,65	357,15	428,25	458,70	485,45 €
D.140 mm.	HSS	237,50	266,50	316,00	336,70	358,15	376,10	392,15 €
	MD	265,45	306,35	326,30	364,40	437,70	469,15	497,00 €

**190 JUEGO FRESAS PARA PUERTAS DE MUEBLES**

**MEC- ALIMENTACION MECANICA**

Juego de 4 fresas para moldura y contramoldura de muebles.

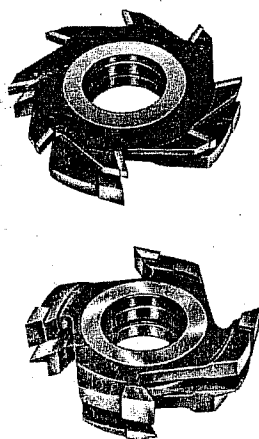

Perfil 4001	D.140 50 eje	HSS MD	499,99 € 565,41 €
Perfil 4002	D.140 50 eje	HSS MD	499,99 € 565,41 €
Perfil 4003	D.140 50 eje	HSS MD	499,99 € 565,41 €
Perfil 4004	D.150 50 eje	HSS MD	501,50 € 571,20 €
Perfil 4005	D.150 50 eje	HSS MD	501,50 € 571,20 €
Perfil 4006	D.150 50 eje	HSS MD	501,50 € 571,20 €
Perfil especial	D.140 50 eje	HSS MD	623,40 € 684,00 €

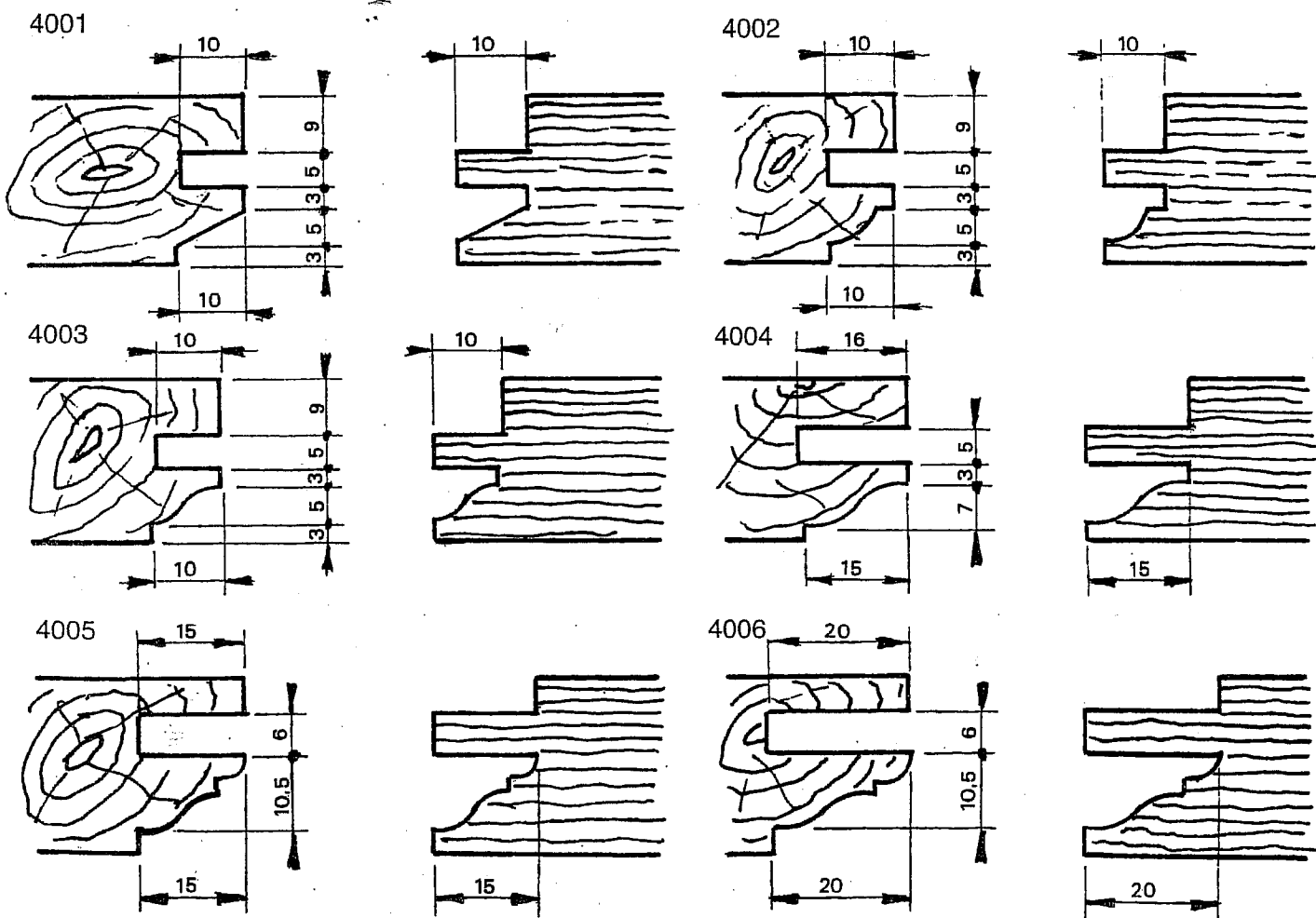

**192 JGO. FRESAS COCINA ESTILO RUSTICO 4 CORTES**

**MEC- ALIMENTACION MECANICA**

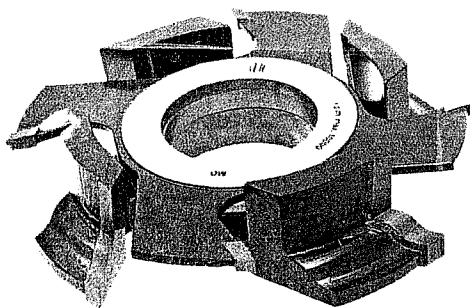

Juego de 6 fresas y 1 cojinete copiador.  
Para madera de 22 a 32 mm.  
Perfil 1004

**DETALLE DE LAS HERRAMIENTAS**

092/A	Fresa ranurar	D.152x5x50 mm.
092/B	Fresa moldurar	D.150x35x50 mm.
092/C	Cojinete tope	D.120 50 mm.
092/D	Fresa espigar	D.160x15x50 mm.
092/E	Fresa contramoldurar	D.160x18x50 mm.
092/F	Fresa plafones	D.210x18x50 mm.
092/G	Fresa recortadora	D.120x10x50 mm.

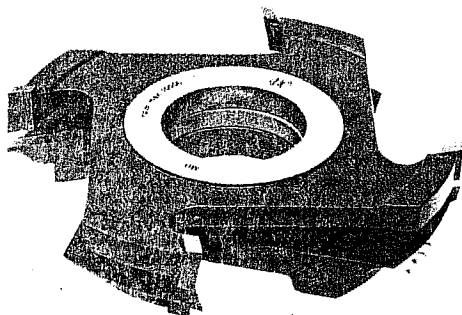

Precio del juego completo	HSS	943,10 €
	MD	1.070,00 €

Fresa ranurar D.152x6x50 eje	HSS	84,20€
	MD	89,90 €

Jgo. fresas ranurar 4Z+4V		
D.152x5/9.6x50 eje	MD	251,00 €

**PERFILES Y FORMAS DE TRABAJO**

